

Computer Vision - Lecture 19

Uncalibrated Reconstruction

23.01.2017

Bastian Leibe

RWTH Aachen

<http://www.vision.rwth-aachen.de>

leibe@vision.rwth-aachen.de

Course Outline

- Image Processing Basics
- Segmentation & Grouping
- Object Recognition
- Local Features & Matching
- Object Categorization
- 3D Reconstruction
 - Epipolar Geometry and Stereo Basics
 - Camera calibration & **Uncalibrated Reconstruction**
 - **Active Stereo**
 - Structure-from-Motion
- Motion and Tracking

Recap: A General Point

- Equations of the form

$$Ax = 0$$

- How do we solve them? (always!)

- Apply SVD

$$\begin{array}{c} \text{SVD} \\ \downarrow \\ A = UDV^T = U \end{array} \begin{array}{c} \left[\begin{array}{ccc} d_{11} & & \\ & \ddots & \\ & & d_{NN} \end{array} \right] \end{array} \begin{array}{c} \left[\begin{array}{ccc} v_{11} & \cdots & v_{1N} \\ \vdots & \ddots & \vdots \\ v_{N1} & \cdots & v_{NN} \end{array} \right]^T \end{array}$$

Singular values Singular vectors

- Singular values of A = square roots of the eigenvalues of $A^T A$.
- The solution of $Ax=0$ is the *nullspace* vector of A .
- This corresponds to the *smallest singular vector* of A .

Recap: Camera Parameters

- Intrinsic parameters

- Principal point coordinates
- Focal length
- Pixel magnification factors
- *Skew (non-rectangular pixels)*
- *Radial distortion*

$$K = \begin{bmatrix} m_x & & \\ & m_y & \\ & & 1 \end{bmatrix} \begin{bmatrix} f & \mathbf{S} & p_x \\ & f & p_y \\ & & 1 \end{bmatrix} = \begin{bmatrix} \alpha_x & \mathbf{S} & x_0 \\ & \alpha_y & y_0 \\ & & 1 \end{bmatrix}$$

- Extrinsic parameters

- Rotation R
- Translation t
(both relative to world coordinate system)

- Camera projection matrix

$$P = K [R | t]$$

- ⇒ General pinhole camera: 9 DoF
- ⇒ CCD Camera with square pixels: 10 DoF
- ⇒ General camera: 11 DoF

Recap: Calibrating a Camera

Goal

- Compute intrinsic and extrinsic parameters using observed camera data.

Main idea

- Place “calibration object” with known geometry in the scene
- Get correspondences
- Solve for mapping from scene to image: estimate $P = P_{\text{int}} P_{\text{ext}}$

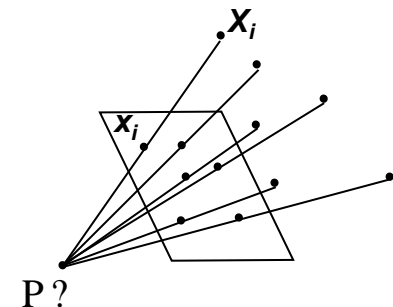
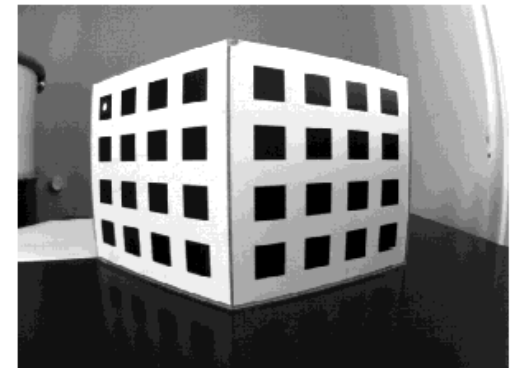
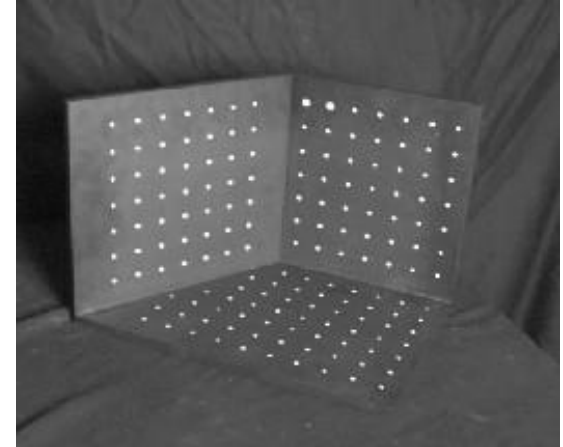

Recap: Camera Calibration (DLT Algorithm)

$$\begin{bmatrix} 0^T & \mathbf{X}_1^T & -y_1 \mathbf{X}_1^T \\ \mathbf{X}_1^T & 0^T & -x_1 \mathbf{X}_1^T \\ \dots & \dots & \dots \\ 0^T & \mathbf{X}_n^T & -y_n \mathbf{X}_n^T \\ \mathbf{X}_n^T & 0^T & -x_n \mathbf{X}_n^T \end{bmatrix} \begin{pmatrix} \mathbf{P}_1 \\ \mathbf{P}_2 \\ \mathbf{P}_3 \end{pmatrix} = 0 \quad \mathbf{A}\mathbf{p} = 0$$

- **P has 11 degrees of freedom.**
- **Two linearly independent equations per independent 2D/3D correspondence.**
- **Solve with SVD (similar to homography estimation)**
 - **Solution corresponds to smallest singular vector.**
- **5 ½ correspondences needed for a minimal solution.**

Topics of This Lecture

- **Revisiting Epipolar Geometry**
 - Triangulation
 - Calibrated case: Essential matrix
 - Uncalibrated case: Fundamental matrix
 - Weak calibration
 - Epipolar Transfer
- **Active Stereo**
 - Kinect sensor
 - Structured Light sensing
 - Laser scanning

Two-View Geometry

- **Scene geometry (structure):**
 - Given corresponding points in two or more images, where is the pre-image of these points in 3D?
- **Correspondence (stereo matching):**
 - Given a point in just one image, how does it constrain the position of the corresponding point x' in another image?
- **Camera geometry (motion):**
 - Given a set of corresponding points in two images, what are the cameras for the two views?

Revisiting Triangulation

- Given projections of a 3D point in two or more images (with known camera matrices), find the coordinates of the point

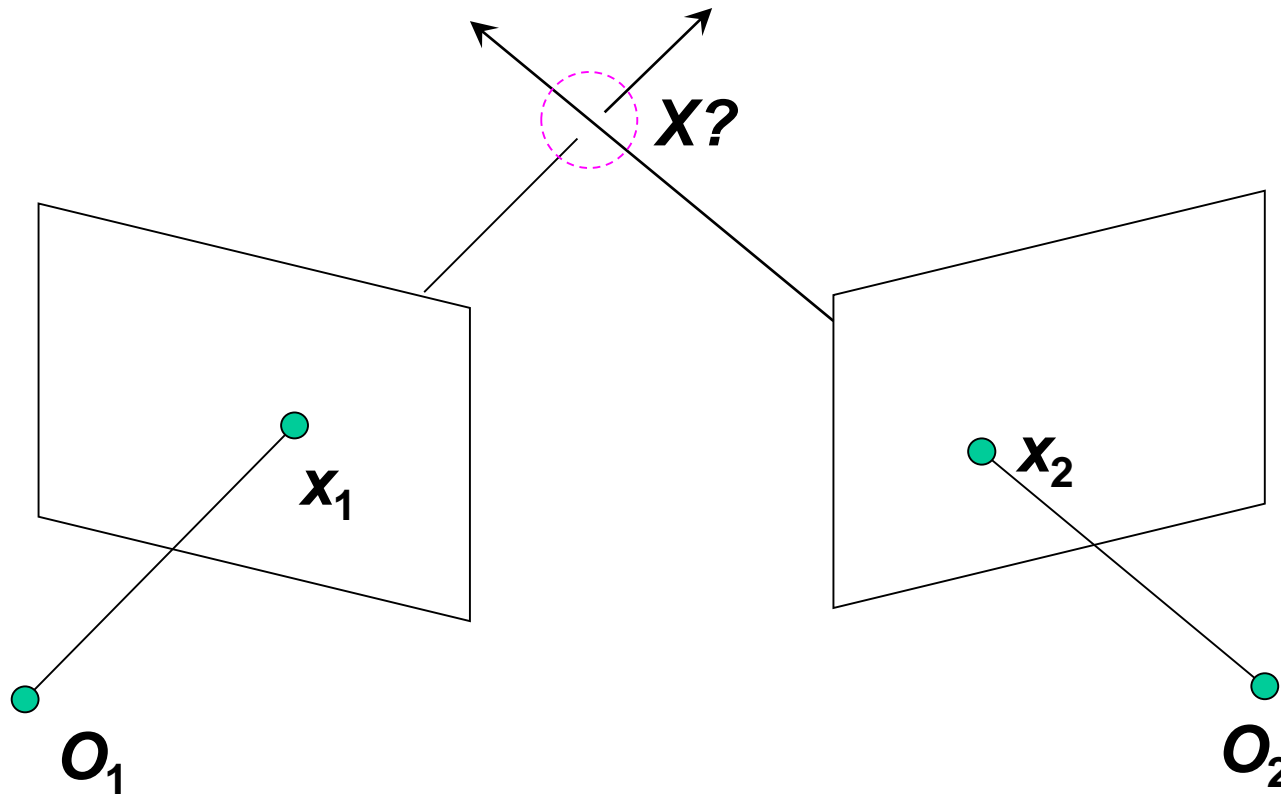

Revisiting Triangulation

- We want to intersect the two visual rays corresponding to x_1 and x_2 , but because of noise and numerical errors, they will never meet exactly. How can this be done?

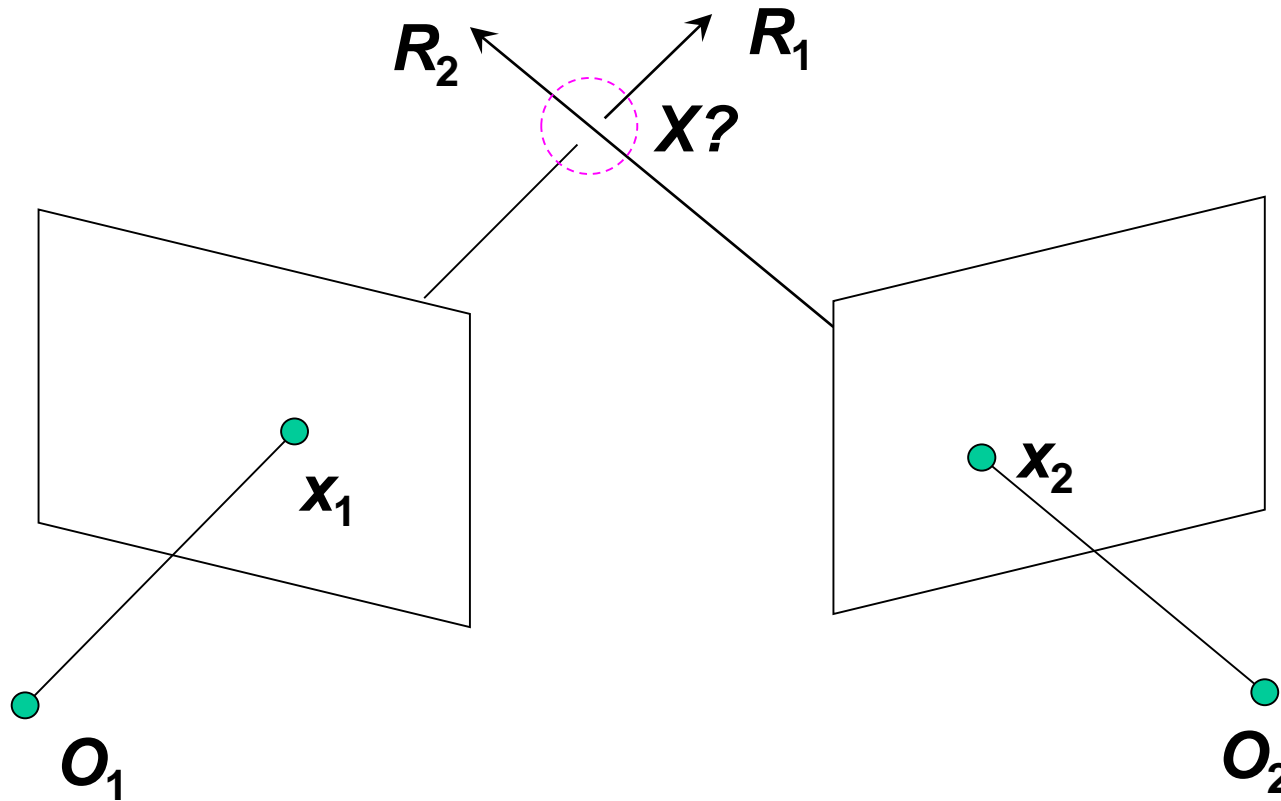

Triangulation: 1) Geometric Approach

- Find shortest segment connecting the two viewing rays and let X be the midpoint of that segment.

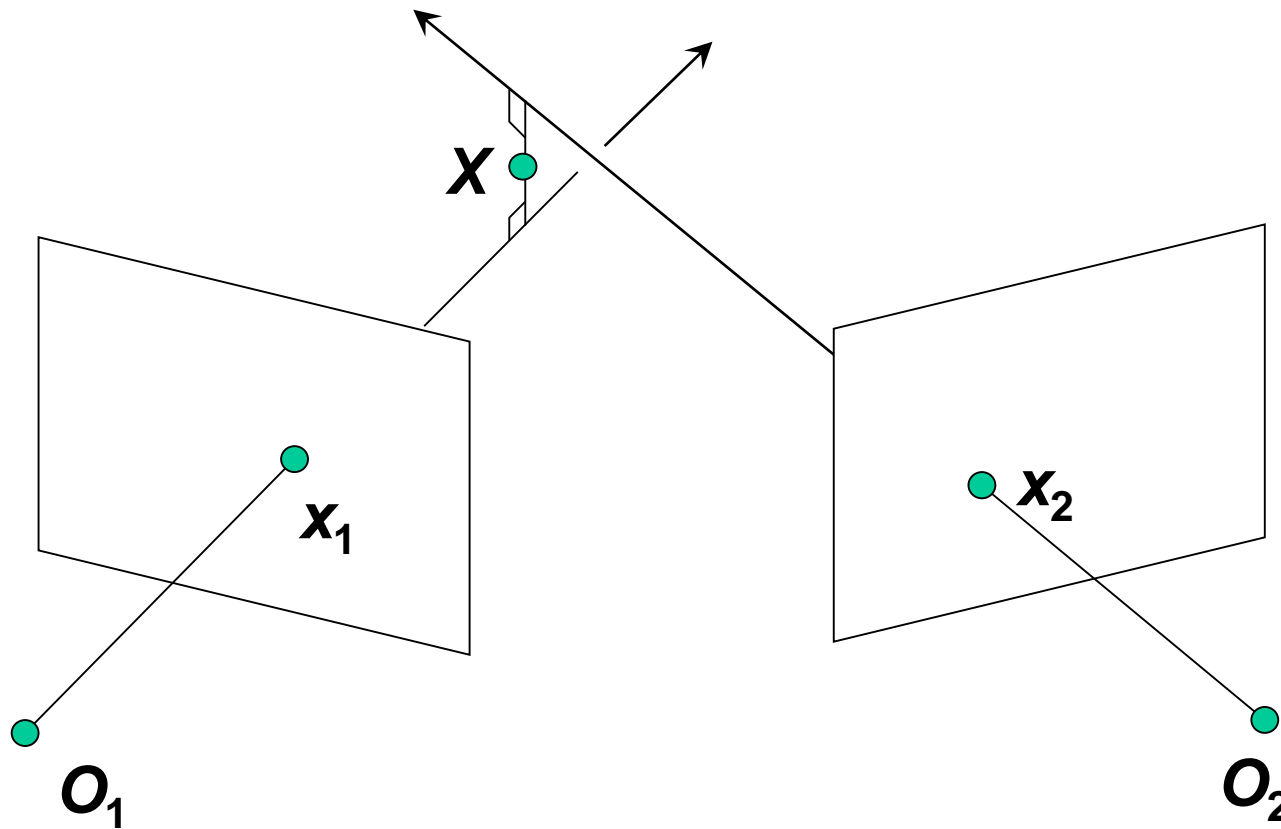

Triangulation: 2) Linear Algebraic Approach

$$\lambda_1 \mathbf{x}_1 = \mathbf{P}_1 \mathbf{X} \quad \mathbf{x}_1 \times \mathbf{P}_1 \mathbf{X} = 0 \quad [\mathbf{x}_{1 \times}] \mathbf{P}_1 \mathbf{X} = 0$$

$$\lambda_2 \mathbf{x}_2 = \mathbf{P}_2 \mathbf{X} \quad \mathbf{x}_2 \times \mathbf{P}_2 \mathbf{X} = 0 \quad [\mathbf{x}_{2 \times}] \mathbf{P}_2 \mathbf{X} = 0$$

Cross product as matrix multiplication:

$$\mathbf{a} \times \mathbf{b} = \begin{bmatrix} 0 & -a_z & a_y \\ a_z & 0 & -a_x \\ -a_y & a_x & 0 \end{bmatrix} \begin{bmatrix} b_x \\ b_y \\ b_z \end{bmatrix} = [\mathbf{a}_{\times}] \mathbf{b}$$

Triangulation: 2) Linear Algebraic Approach

$$\lambda_1 \mathbf{x}_1 = \mathbf{P}_1 \mathbf{X} \quad \mathbf{x}_1 \times \mathbf{P}_1 \mathbf{X} = 0 \quad [\mathbf{x}_{1 \times}] \mathbf{P}_1 \mathbf{X} = 0$$

$$\lambda_2 \mathbf{x}_2 = \mathbf{P}_2 \mathbf{X} \quad \mathbf{x}_2 \times \mathbf{P}_2 \mathbf{X} = 0 \quad [\mathbf{x}_{2 \times}] \mathbf{P}_2 \mathbf{X} = 0$$



Two independent equations each in terms of three unknown entries of X

⇒ Stack them and solve using SVD!

- This approach is often preferable to the geometric approach, since it nicely generalizes to multiple cameras.

Triangulation: 3) Nonlinear Approach

- Find X that minimizes

$$d^2(x_1, P_1 X) + d^2(x_2, P_2 X)$$

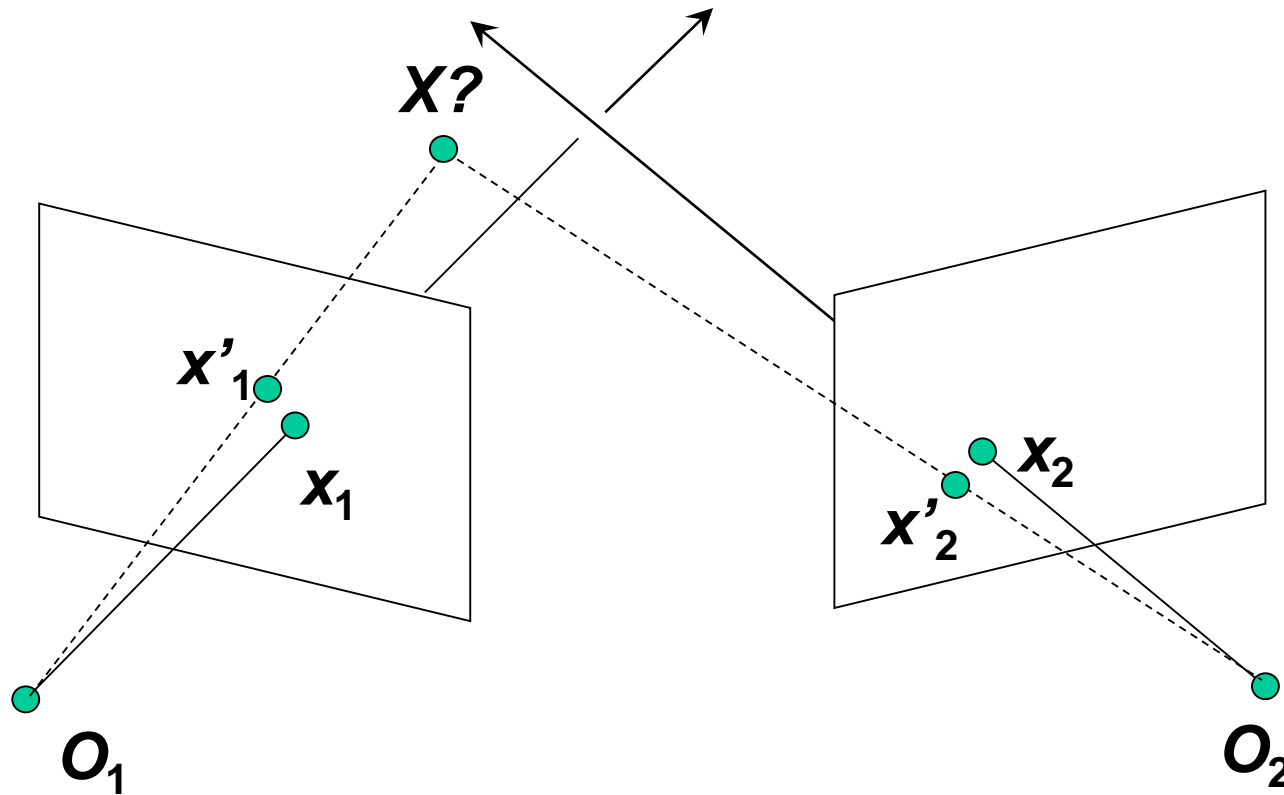

Triangulation: 3) Nonlinear Approach

- Find X that minimizes

$$d^2(x_1, P_1 X) + d^2(x_2, P_2 X)$$

- This approach is the most accurate, but unlike the other two methods, it doesn't have a closed-form solution.
- Iterative algorithm
 - Initialize with linear estimate.
 - Optimize with Gauss-Newton or Levenberg-Marquardt (see F&P sec. 3.1.2 or H&Z Appendix 6).

Revisiting Epipolar Geometry

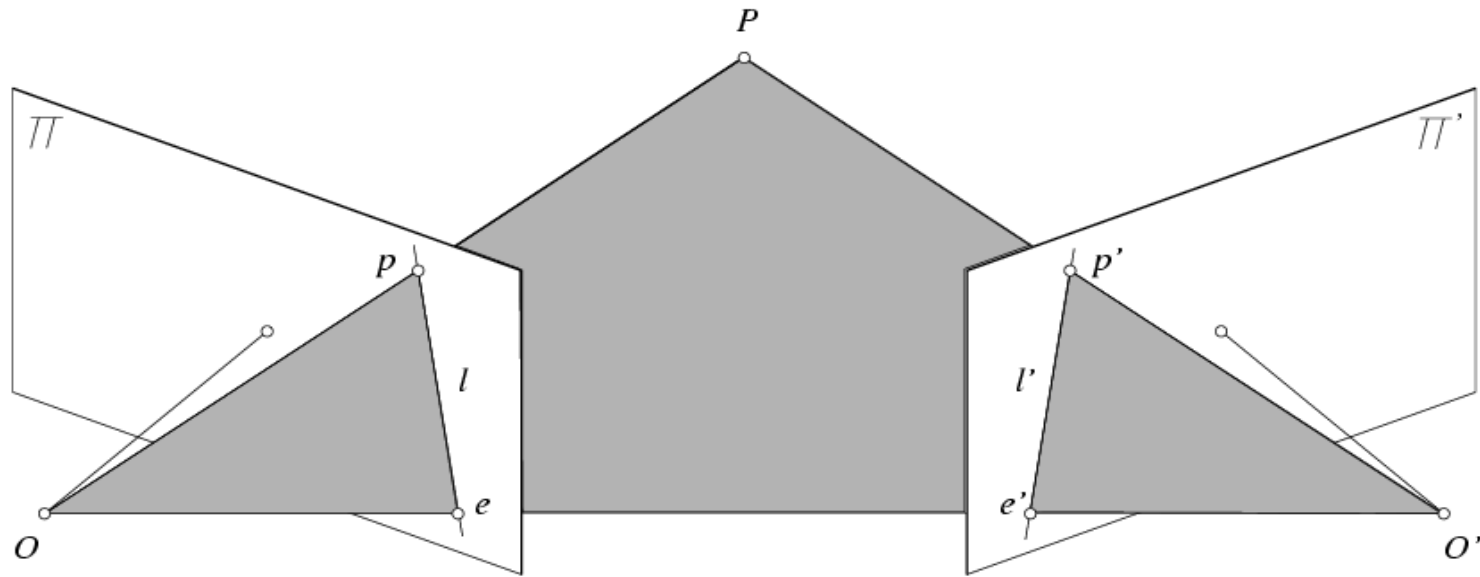

- Let's look again at the epipolar constraint
 - For the calibrated case (but in homogenous coordinates)
 - For the uncalibrated case

Epipolar Geometry: Calibrated Case

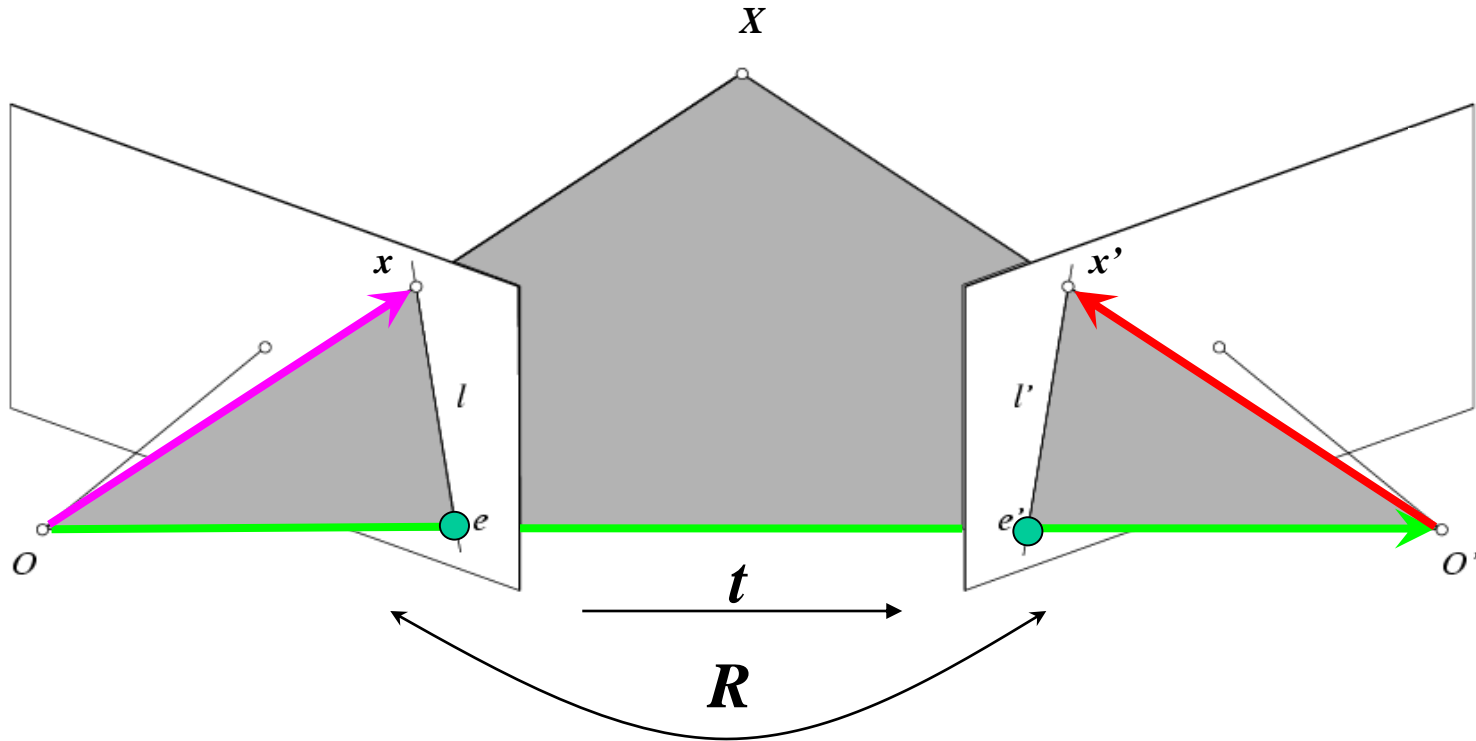

Camera matrix: $[I|0]$

$$X = (u, v, w, 1)^T$$

$$x = (u, v, w)^T$$

Camera matrix: $[R^T | -R^T t]$

Vector x' in second coord. system has coordinates Rx' in the first one.

The vectors x , t , and Rx' are coplanar

Epipolar Geometry: Calibrated Case

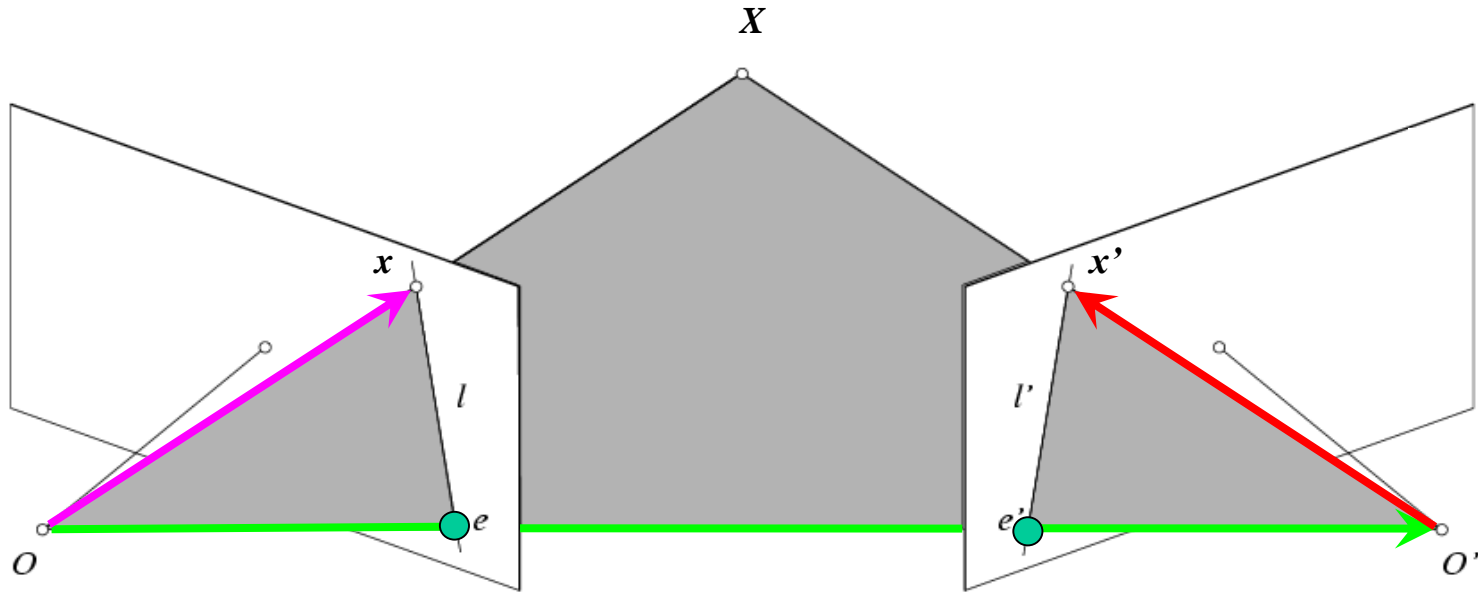

$$x \cdot [t \times (Rx')] = 0 \quad \Rightarrow \quad x^T E x' = 0 \quad \text{with} \quad E = [t_{\times}] R$$



**Essential Matrix
(Longuet-Higgins, 1981)**

Epipolar Geometry: Calibrated Case

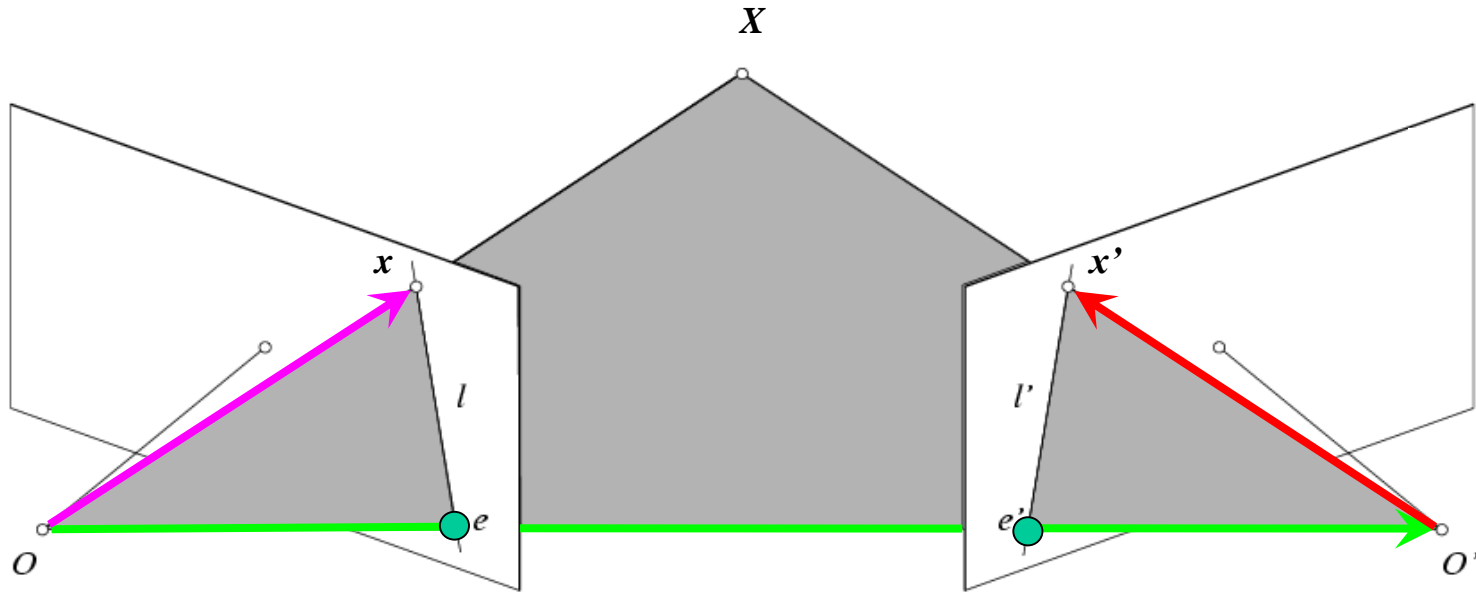

$$x \cdot [t \times (Rx')] = 0 \quad \Rightarrow \quad x^T E x' = 0 \quad \text{with} \quad E = [t_{\times}] R$$

- $E x'$ is the epipolar line associated with x' ($l = E x'$)
- $E^T x$ is the epipolar line associated with x ($l' = E^T x$)
- $E e' = 0$ and $E^T e = 0$
- E is singular (rank two)
- E has five degrees of freedom (up to scale)

Epipolar Geometry: Uncalibrated Case

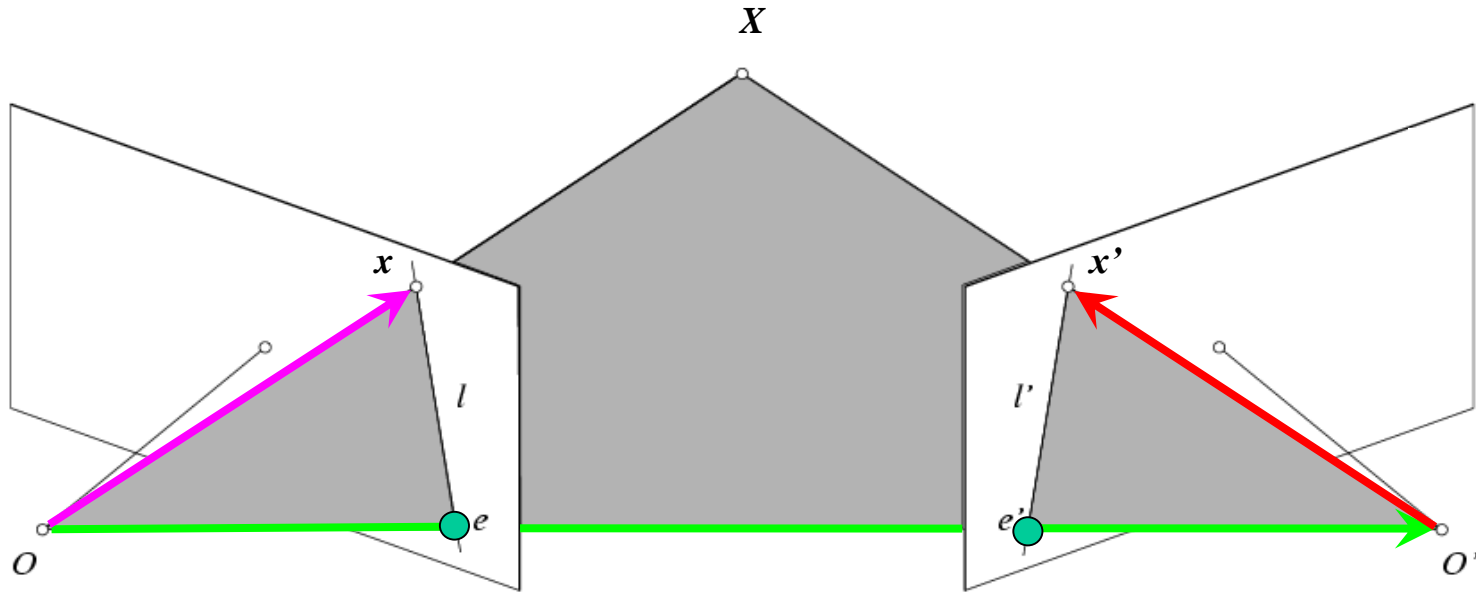

- The calibration matrices K and K' of the two cameras are unknown
- We can write the epipolar constraint in terms of *unknown* normalized coordinates:

$$\hat{x}^T E \hat{x}' = 0 \quad x = K \hat{x}, \quad x' = K' \hat{x}'$$

Epipolar Geometry: Uncalibrated Case

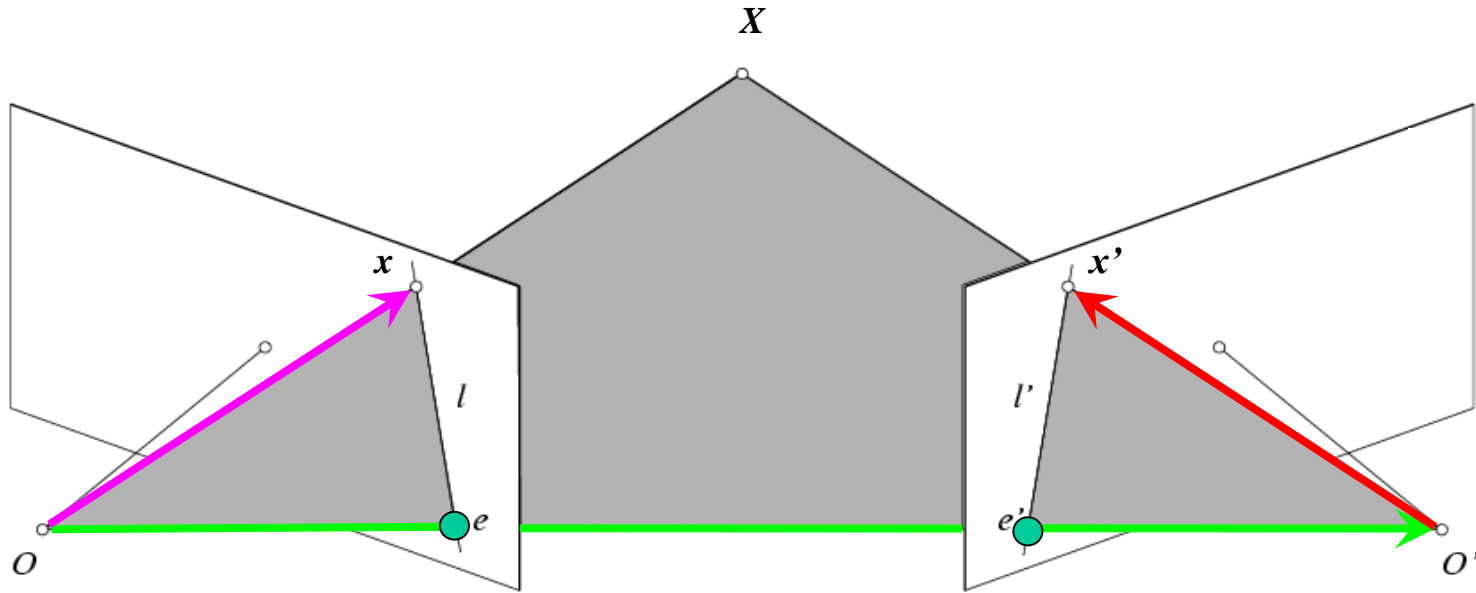

$$\hat{x}^T E \hat{x}' = 0 \quad \Rightarrow \quad x^T F x' = 0 \quad \text{with} \quad F = K^{-T} E K'^{-1}$$

$$x = K \hat{x}$$

$$x' = K' \hat{x}'$$

Fundamental Matrix
(Faugeras and Luong, 1992)

Epipolar Geometry: Uncalibrated Case

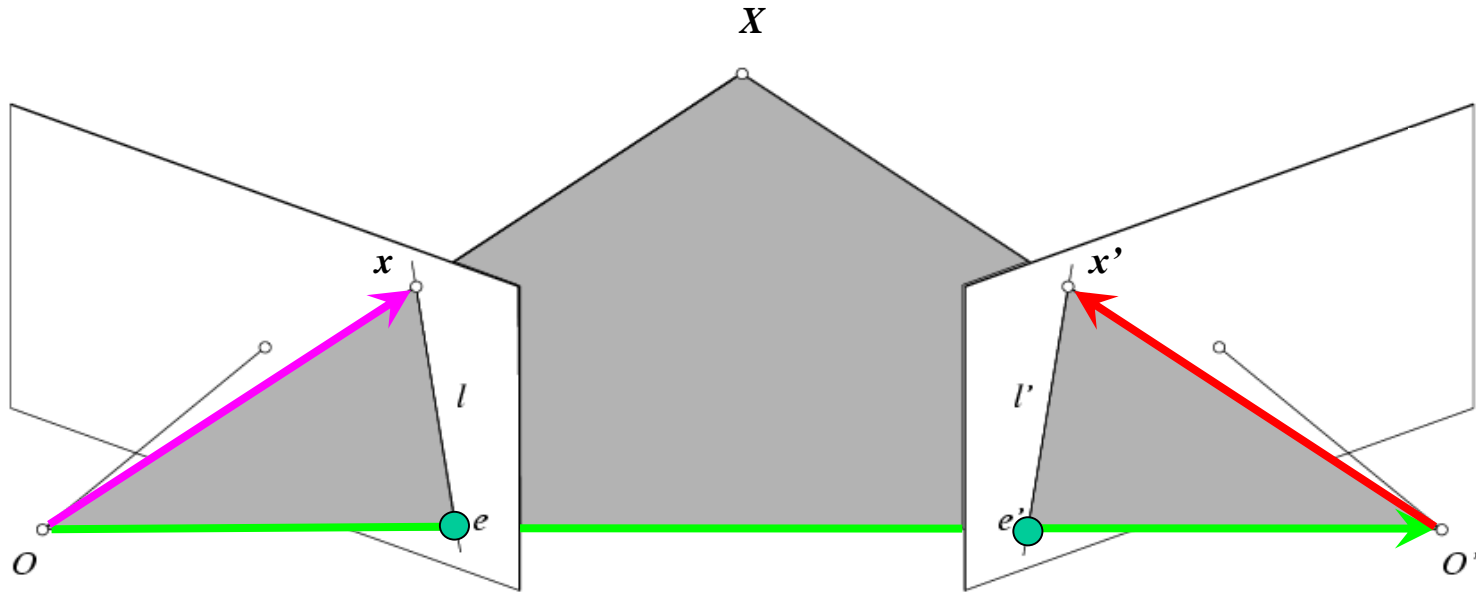

$$\hat{x}^T E \hat{x}' = 0 \quad \longrightarrow \quad x^T F x' = 0 \quad \text{with} \quad F = K^{-T} E K'^{-1}$$

- $F x'$ is the epipolar line associated with x' ($l = F x'$)
- $F^T x$ is the epipolar line associated with x ($l' = F^T x$)
- $F e' = 0$ and $F^T e = 0$
- F is singular (rank two)
- F has seven degrees of freedom

Estimating the Fundamental Matrix

- The Fundamental matrix defines the epipolar geometry between two uncalibrated cameras.
- How can we estimate F from an image pair?
 - We need correspondences...

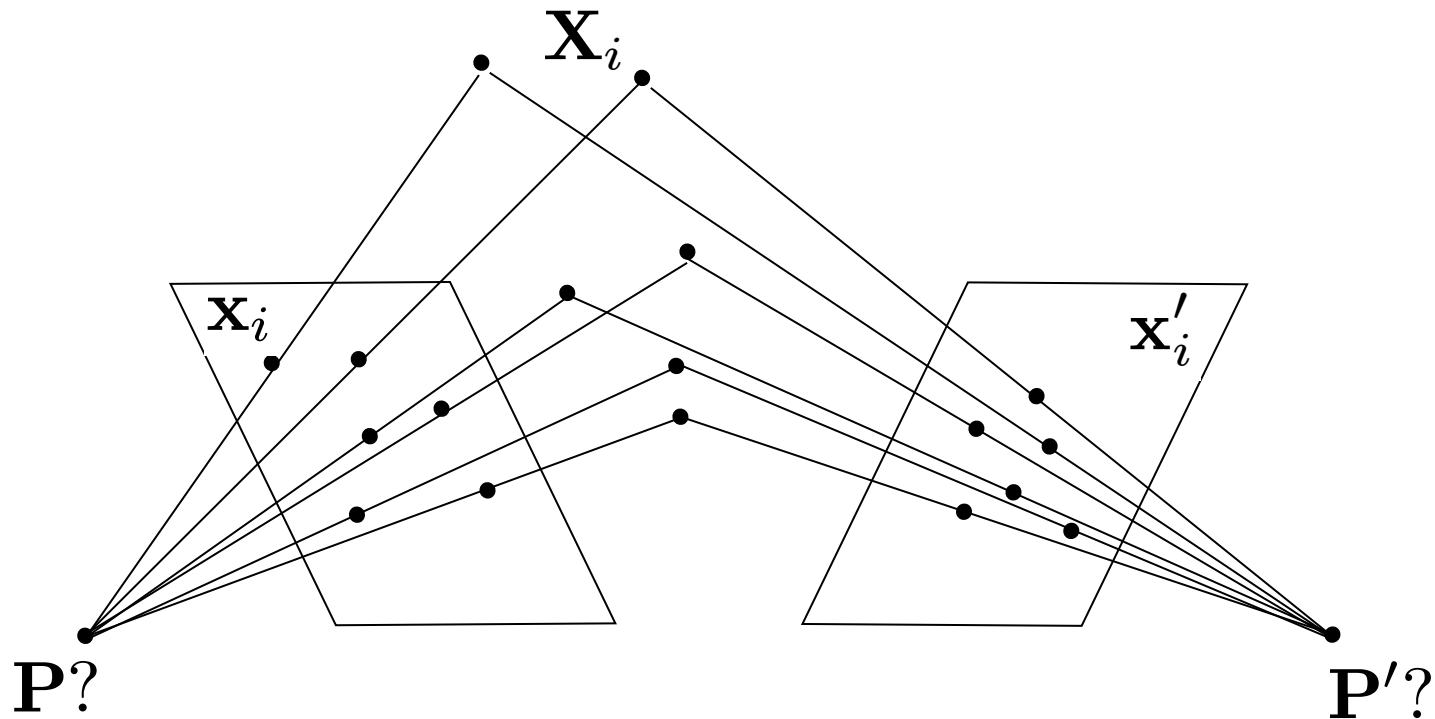

The Eight-Point Algorithm

$$\mathbf{x} = (u, v, 1)^T, \quad \mathbf{x}' = (u', v', 1)^T$$

$$(u, v, 1) \begin{pmatrix} F_{11} & F_{12} & F_{13} \\ F_{21} & F_{22} & F_{23} \\ F_{31} & F_{32} & F_{33} \end{pmatrix} \begin{pmatrix} u' \\ v' \\ 1 \end{pmatrix} = 0 \quad \rightarrow \quad [u'u, u'v, u', uv', vv', v', u, v, 1] \begin{bmatrix} F_{11} \\ F_{12} \\ F_{13} \\ F_{21} \\ F_{22} \\ F_{23} \\ F_{31} \\ F_{32} \\ F_{33} \end{bmatrix} = 0$$

- Taking 8 correspondences:

$$\begin{bmatrix} u'_1 u_1 & u'_1 v_1 & u'_1 & u_1 v'_1 & v_1 v'_1 & v'_1 & u_1 & v_1 & 1 \\ u'_2 u_2 & u'_2 v_2 & u'_2 & u_2 v'_2 & v_2 v'_2 & v'_2 & u_2 & v_2 & 1 \\ u'_3 u_3 & u'_3 v_3 & u'_3 & u_3 v'_3 & v_3 v'_3 & v'_3 & u_3 & v_3 & 1 \\ u'_4 u_4 & u'_4 v_4 & u'_4 & u_4 v'_4 & v_4 v'_4 & v'_4 & u_4 & v_4 & 1 \\ u'_5 u_5 & u'_5 v_5 & u'_5 & u_5 v'_5 & v_5 v'_5 & v'_5 & u_5 & v_5 & 1 \\ u'_6 u_6 & u'_6 v_6 & u'_6 & u_6 v'_6 & v_6 v'_6 & v'_6 & u_6 & v_6 & 1 \\ u'_7 u_7 & u'_7 v_7 & u'_7 & u_7 v'_7 & v_7 v'_7 & v'_7 & u_7 & v_7 & 1 \\ u'_8 u_8 & u'_8 v_8 & u'_8 & u_8 v'_8 & v_8 v'_8 & v'_8 & u_8 & v_8 & 1 \end{bmatrix} \begin{bmatrix} F_{11} \\ F_{12} \\ F_{13} \\ F_{21} \\ F_{22} \\ F_{23} \\ F_{31} \\ F_{32} \\ F_{33} \end{bmatrix} = \begin{bmatrix} 0 \\ 0 \\ 0 \\ 0 \\ 0 \\ 0 \\ 0 \\ 0 \\ 0 \end{bmatrix}$$

$$A\mathbf{f} = 0$$

Solve using... SVD!

This minimizes:

$$\sum_{i=1}^N (\mathbf{x}_i^T F \mathbf{x}'_i)^2$$

Excursion: Properties of SVD

- Frobenius norm

- Generalization of the Euclidean norm to matrices

$$\|A\|_F = \sqrt{\sum_{i=1}^m \sum_{j=1}^n |a_{ij}|^2} = \sqrt{\sum_{i=1}^{\min(m,n)} \sigma_i^2}$$

- Partial reconstruction property of SVD

- Let $\sigma_i, i=1, \dots, N$ be the singular values of A .
- Let $A_p = U_p D_p V_p^T$ be the reconstruction of A when we set $\sigma_{p+1}, \dots, \sigma_N$ to zero.
- Then $A_p = U_p D_p V_p^T$ is the best rank- p approximation of A in the sense of the Frobenius norm (i.e. the best least-squares approximation).

The Eight-Point Algorithm

- Problem with noisy data
 - The solution will usually not fulfill the constraint that F only has rank 2.
 - ⇒ *There will be no epipoles through which all epipolar lines pass!*

- Enforce the rank-2 constraint using SVD

$$F \stackrel{\text{SVD}}{=} U D V^T = U \begin{bmatrix} d_{11} & & & \\ & d_{22} & & \\ & & d_{33} & \\ & & & & & \end{bmatrix} \begin{bmatrix} v_{11} & \cdots & v_{13} \\ \vdots & \ddots & \vdots \\ v_{31} & \cdots & v_{33} \end{bmatrix}^T$$

Set d_{33} to zero and reconstruct F

- As we have just seen, this provides the best least-squares approximation to the rank-2 solution.

Problem with the Eight-Point Algorithm

- In practice, this often looks as follows:

$$\begin{bmatrix} u'_1 u_1 & u'_1 v_1 & u'_1 & u_1 v'_1 & v_1 v'_1 & v'_1 & u_1 & v_1 & 1 \\ u'_2 u_2 & u'_2 v_2 & u'_2 & u_2 v'_2 & v_2 v'_2 & v'_2 & u_2 & v_2 & 1 \\ u'_3 u_3 & u'_3 v_3 & u'_3 & u_3 v'_3 & v_3 v'_3 & v'_3 & u_3 & v_3 & 1 \\ u'_4 u_4 & u'_4 v_4 & u'_4 & u_4 v'_4 & v_4 v'_4 & v'_4 & u_4 & v_4 & 1 \\ u'_5 u_5 & u'_5 v_5 & u'_5 & u_5 v'_5 & v_5 v'_5 & v'_5 & u_5 & v_5 & 1 \\ u'_6 u_6 & u'_6 v_6 & u'_6 & u_6 v'_6 & v_6 v'_6 & v'_6 & u_6 & v_6 & 1 \\ u'_7 u_7 & u'_7 v_7 & u'_7 & u_7 v'_7 & v_7 v'_7 & v'_7 & u_7 & v_7 & 1 \\ u'_8 u_8 & u'_8 v_8 & u'_8 & u_8 v'_8 & v_8 v'_8 & v'_8 & u_8 & v_8 & 1 \end{bmatrix} \begin{bmatrix} F_{11} \\ F_{12} \\ F_{13} \\ F_{21} \\ F_{22} \\ F_{23} \\ F_{31} \\ F_{32} \\ F_{33} \end{bmatrix} = \begin{bmatrix} 0 \\ 0 \\ 0 \\ 0 \\ 0 \\ 0 \\ 0 \\ 0 \\ 0 \end{bmatrix}$$

Problem with the Eight-Point Algorithm

- In practice, this often looks as follows:

250906.36	183269.57	921.81	200931.10	146766.13	738.21	272.19	198.81
2692.28	131633.03	176.27	6196.73	302975.59	405.71	15.27	746.79
416374.23	871684.30	935.47	408110.89	854384.92	916.90	445.10	931.81
191183.60	171759.40	410.27	416435.62	374125.90	893.65	465.99	418.65
48988.86	30401.76	57.89	298604.57	185309.58	352.87	846.22	525.15
164786.04	546559.67	813.17	1998.37	6628.15	9.86	202.65	672.14
116407.01	2727.75	138.89	169941.27	3982.21	202.77	838.12	19.64
135384.58	75411.13	198.72	411350.03	229127.78	603.79	681.28	379.48

$$\begin{bmatrix} 1 \\ 1 \\ 1 \\ 1 \\ 1 \\ 1 \\ 1 \\ 1 \end{bmatrix} \begin{bmatrix} F_{11} \\ F_{12} \\ F_{13} \\ F_{21} \\ F_{22} \\ F_{23} \\ F_{31} \\ F_{32} \\ F_{33} \end{bmatrix} = \begin{bmatrix} 0 \\ 0 \\ 0 \\ 0 \\ 0 \\ 0 \\ 0 \\ 0 \\ 0 \end{bmatrix}$$

⇒ Poor numerical conditioning

⇒ Can be fixed by rescaling the data

The Normalized Eight-Point Algorithm

1. Center the image data at the origin, and scale it so the mean squared distance between the origin and the data points is 2 pixels.
2. Use the eight-point algorithm to compute F from the normalized points.
3. Enforce the rank-2 constraint using SVD.

$$F \stackrel{\text{SVD}}{=} U D V^T = U \begin{bmatrix} d_{11} & & & \\ & d_{22} & & \\ & & d_{33} & \\ & & & \dots \end{bmatrix} \begin{bmatrix} v_{11} & \cdots & v_{13} \\ \vdots & \ddots & \vdots \\ v_{31} & \cdots & v_{33} \end{bmatrix}^T$$

Set d_{33} to zero and reconstruct F

4. Transform fundamental matrix back to original units: if T and T' are the normalizing transformations in the two images, then the fundamental matrix in original coordinates is $T^T F T'$.

The Eight-Point Algorithm

- Meaning of error $\sum_{i=1}^N (x_i^T F x'_i)^2$:

Sum of Euclidean distances between points x_i and epipolar lines $F x'_i$ (or points x'_i and epipolar lines $F^T x_i$), multiplied by a scale factor

- Nonlinear approach: minimize

$$\sum_{i=1}^N \left[d^2(x_i, F x'_i) + d^2(x'_i, F^T x_i) \right]$$

- Similar to nonlinear minimization approach for triangulation.
- Iterative approach (Gauss-Newton, Levenberg-Marquardt,...)

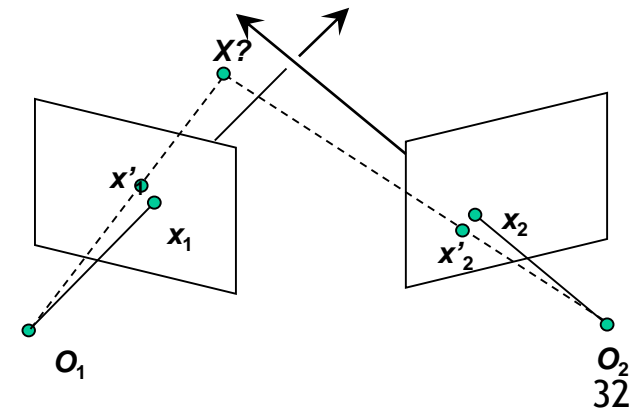

Comparison of Estimation Algorithms

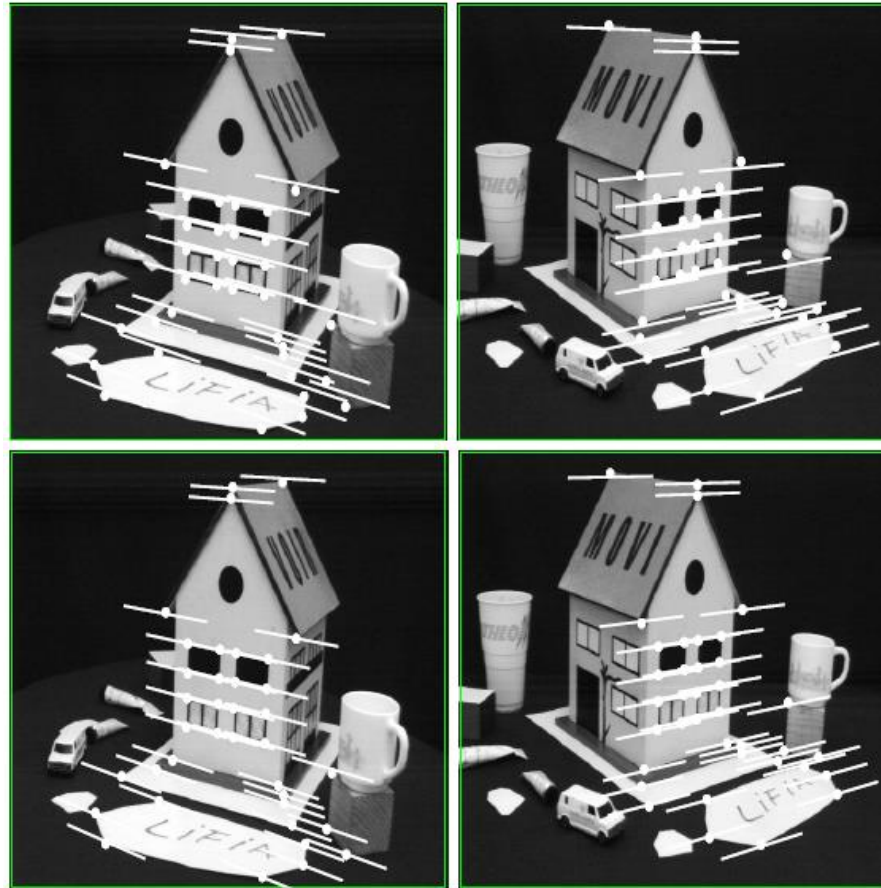

	8-point	Normalized 8-point	Nonlinear least squares
Av. Dist. 1	2.33 pixels	0.92 pixel	0.86 pixel
Av. Dist. 2	2.18 pixels	0.85 pixel	0.80 pixel

3D Reconstruction with Weak Calibration

- Want to estimate world geometry without requiring calibrated cameras.
- Many applications:
 - Archival videos
 - Photos from multiple unrelated users
 - Dynamic camera system
- Main idea:
 - Estimate epipolar geometry from a (redundant) set of point correspondences between two uncalibrated cameras.

Stereo Pipeline with Weak Calibration

- So, where to start with uncalibrated cameras?
 - Need to find fundamental matrix F *and* the correspondences (pairs of points $(u', v') \leftrightarrow (u, v)$).



- Procedure
 1. Find interest points in both images
 2. Compute correspondences
 3. Compute epipolar geometry
 4. Refine

Stereo Pipeline with Weak Calibration

1. Find interest points (e.g. Harris corners)



Stereo Pipeline with Weak Calibration

2. Match points using only proximity

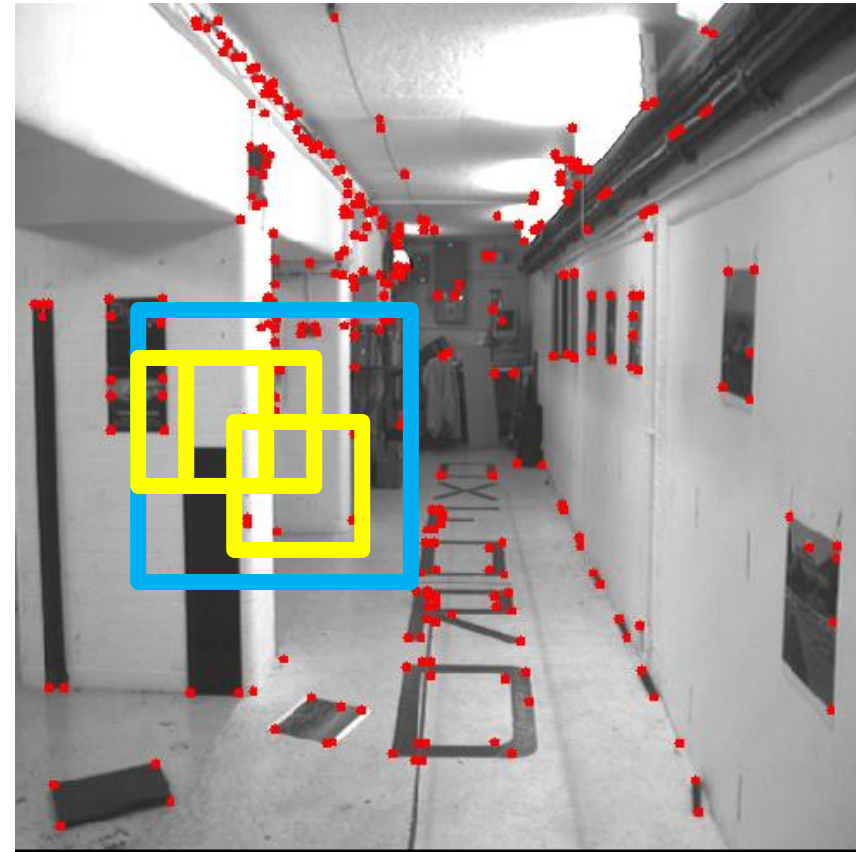

Putative Matches based on Correlation Search

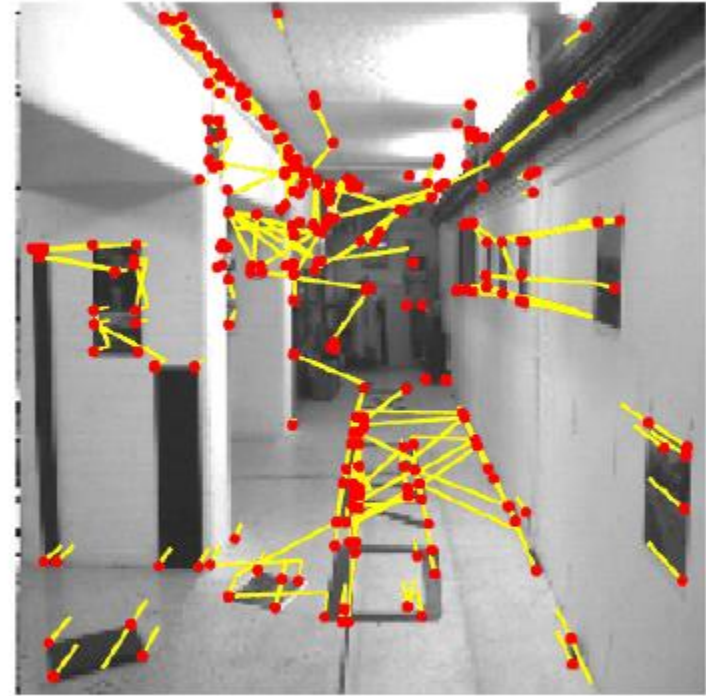

- Many wrong matches (10-50%), but enough to compute F

RANSAC for Robust Estimation of F

- Select random sample of correspondences
- Compute F using them
 - This determines epipolar constraint
- Evaluate amount of support - number of inliers within threshold distance of epipolar line
- Choose F with most support (#inliers)



Putative Matches based on Correlation Search

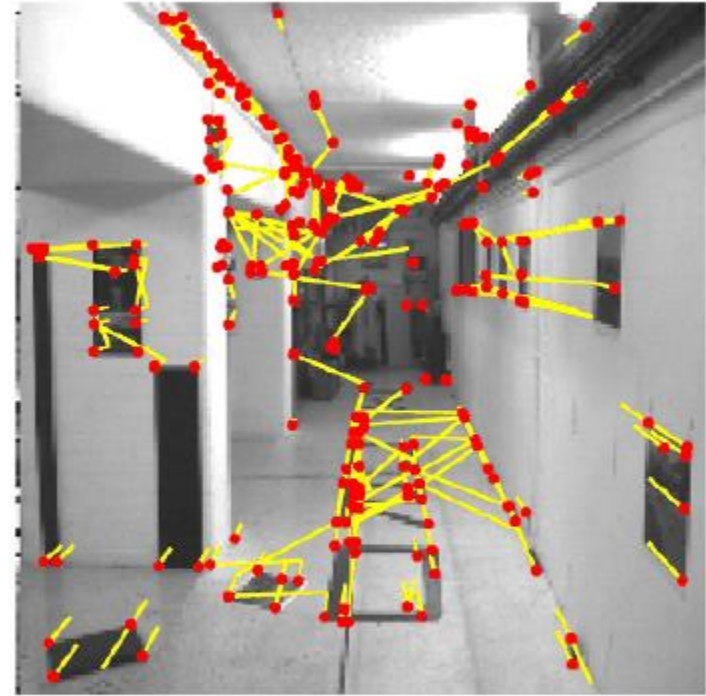

- Many wrong matches (10-50%), but enough to compute F

Pruned Matches

- Correspondences consistent with epipolar geometry

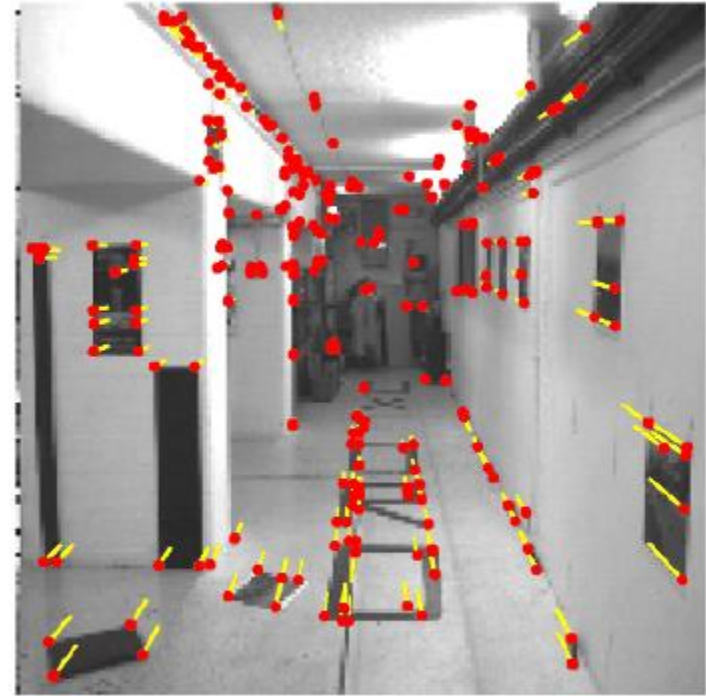

Resulting Epipolar Geometry



Epipolar Transfer

- Assume the epipolar geometry is known
- Given projections of the same point in two images, how can we compute the projection of that point in a third image?

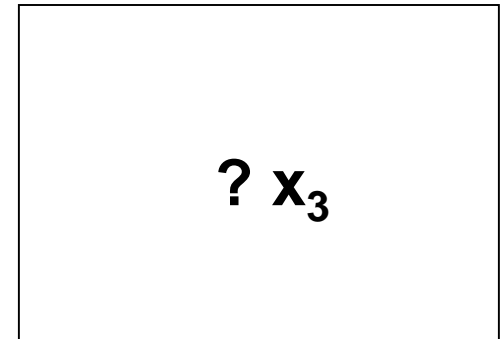
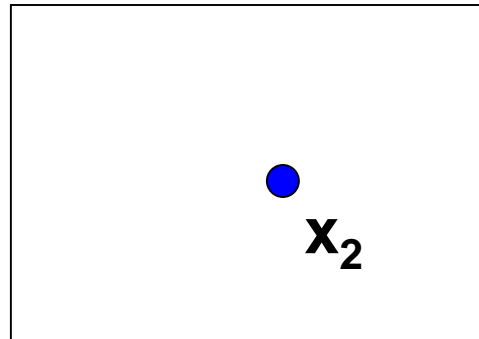
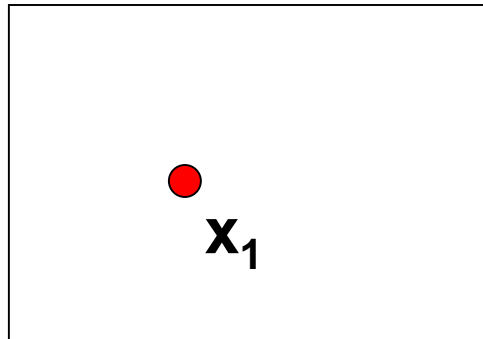

Extension: Epipolar Transfer

- Assume the epipolar geometry is known
- Given projections of the same point in two images, how can we compute the projection of that point in a third image?

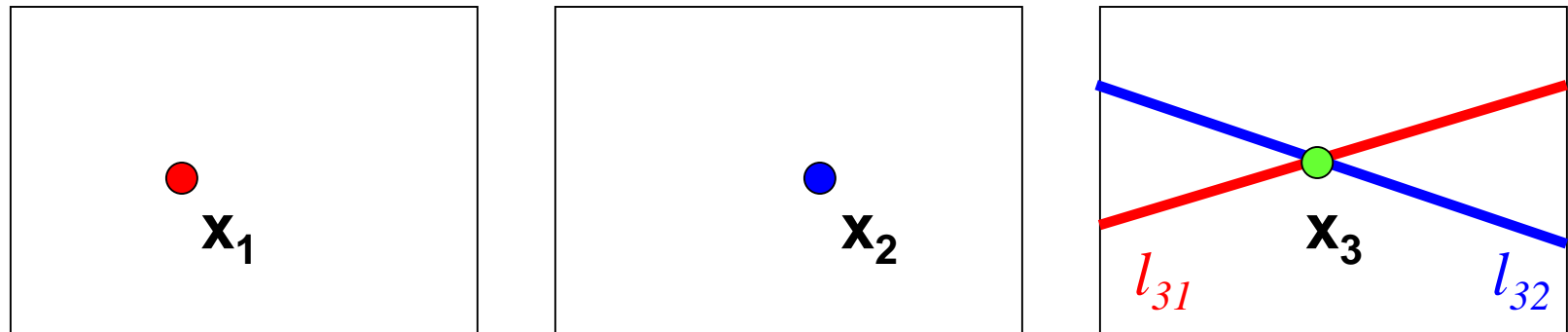

$$l_{31} = F^T_{13} x_1$$

$$l_{32} = F^T_{23} x_2$$

When does epipolar transfer fail?

Topics of This Lecture

- Revisiting Epipolar Geometry
 - Triangulation
 - Calibrated case: Essential matrix
 - Uncalibrated case: Fundamental matrix
 - Weak calibration
 - Epipolar Transfer
- **Active Stereo**
 - **Kinect sensor**
 - **Structured Light sensing**
 - **Laser scanning**

Microsoft Kinect - How Does It Work?

KINECT™
for  XBOX 360.



- Built-in IR projector
- IR camera for depth
- Regular camera for color



Recall: Optical Triangulation

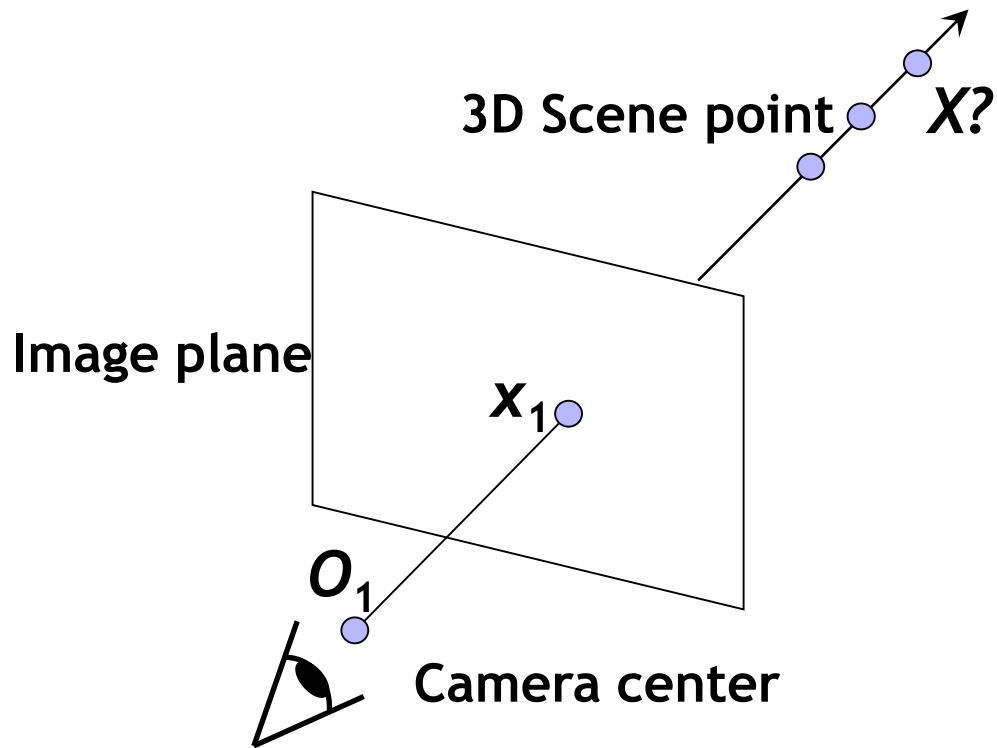

Recall: Optical Triangulation

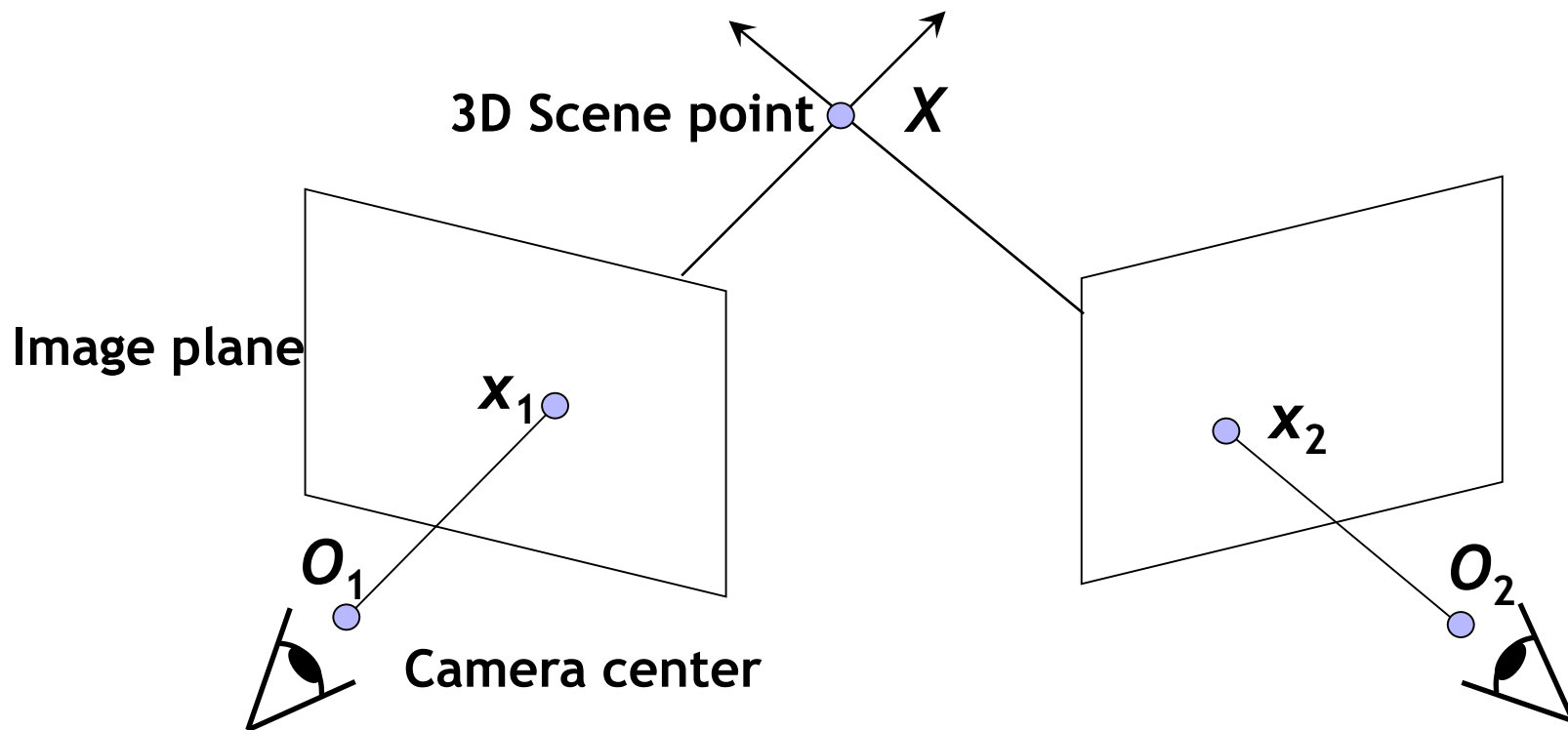

- Principle: 3D point given by intersection of two rays.
 - Crucial information: point correspondence
 - Most expensive and error-prone step in the pipeline...

Active Stereo with Structured Light

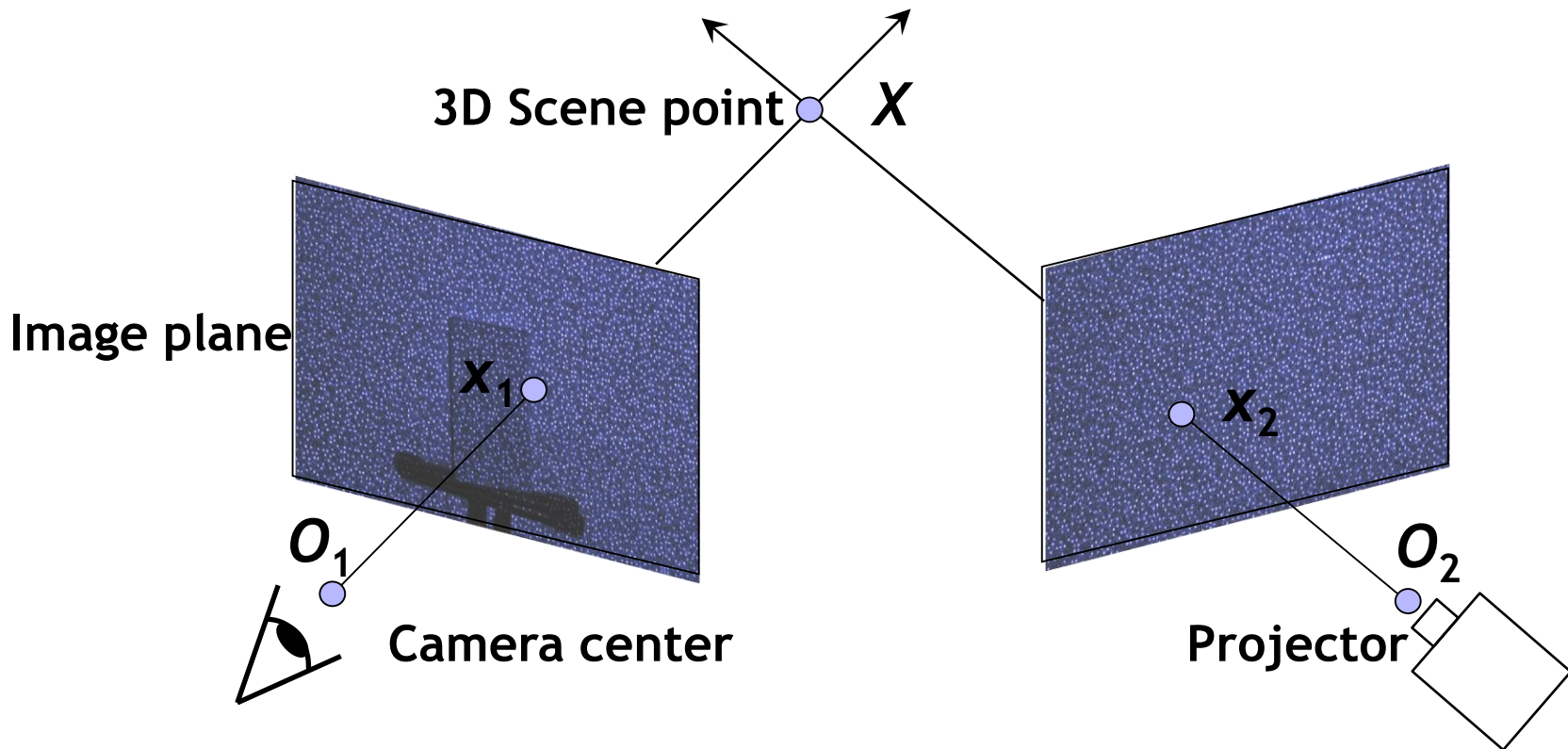

- **Idea: Replace one camera by a projector.**
 - Project “structured” light patterns onto the object
 - Simplifies the correspondence problem

What the Kinect Sees...

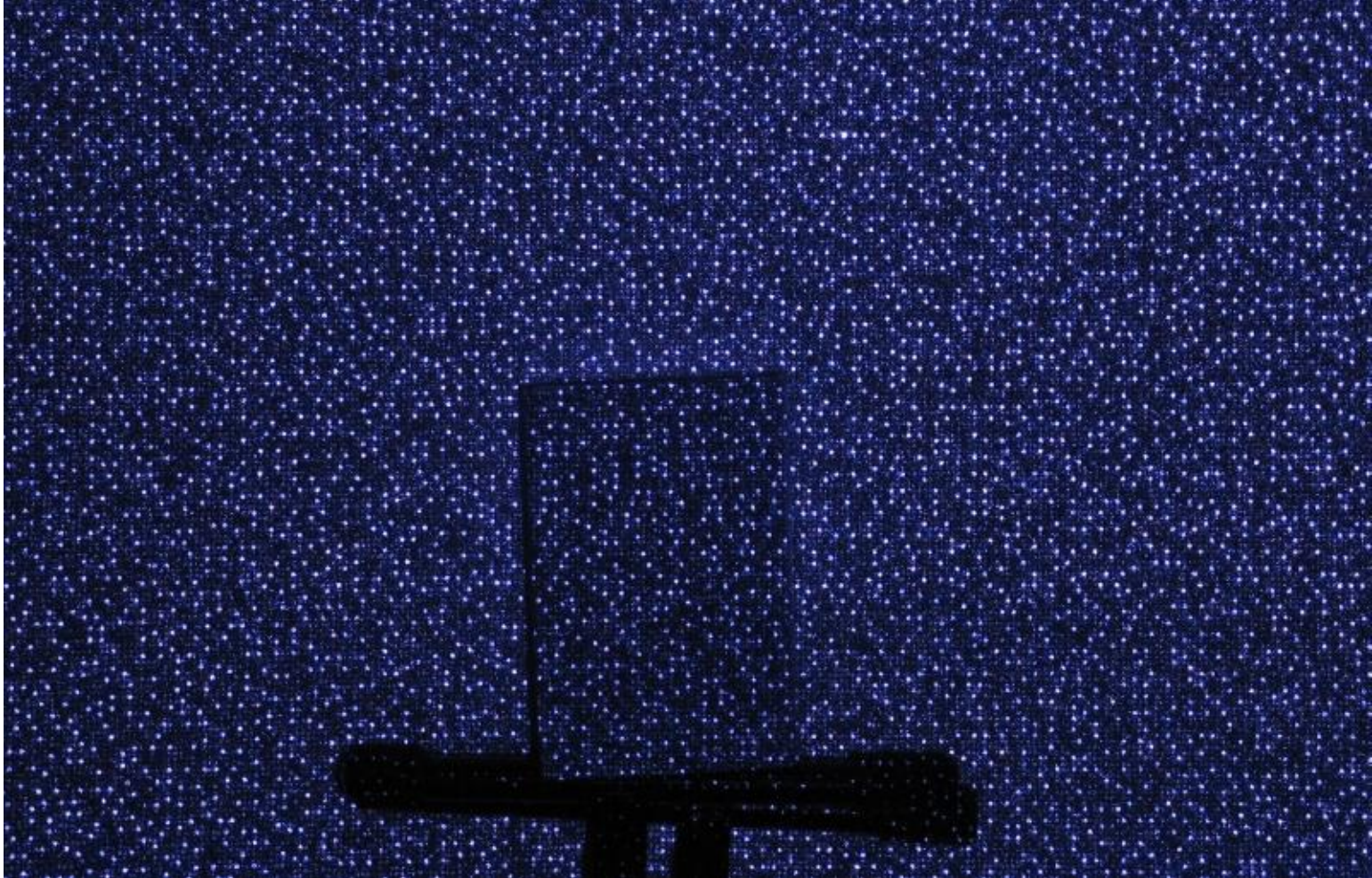

3D Reconstruction with the Kinect



SIGGRAPH Talks 2011

KinectFusion:

**Real-Time Dynamic 3D Surface
Reconstruction and Interaction**

**Shahram Izadi 1, Richard Newcombe 2, David Kim 1,3, Otmar Hilliges 1,
David Molyneaux 1,4, Pushmeet Kohli 1, Jamie Shotton 1,
Steve Hodges 1, Dustin Freeman 5, Andrew Davison 2, Andrew Fitzgibbon 1**

1 Microsoft Research Cambridge 2 Imperial College London
3 Newcastle University 4 Lancaster University
5 University of Toronto

Active Stereo with Structured Light

- Idea: Project “structured” light patterns onto the object
 - Simplifies the correspondence problem
 - Allows us to use only one camera

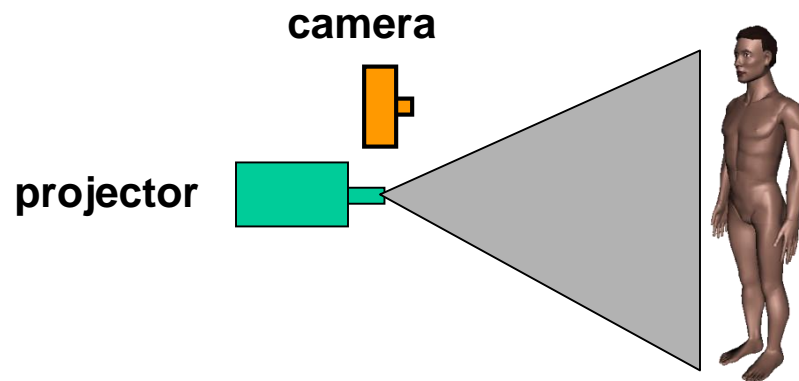

- The Kinect uses one such approach (“structured noise“)
 - What other approaches are possible?

Laser Scanning

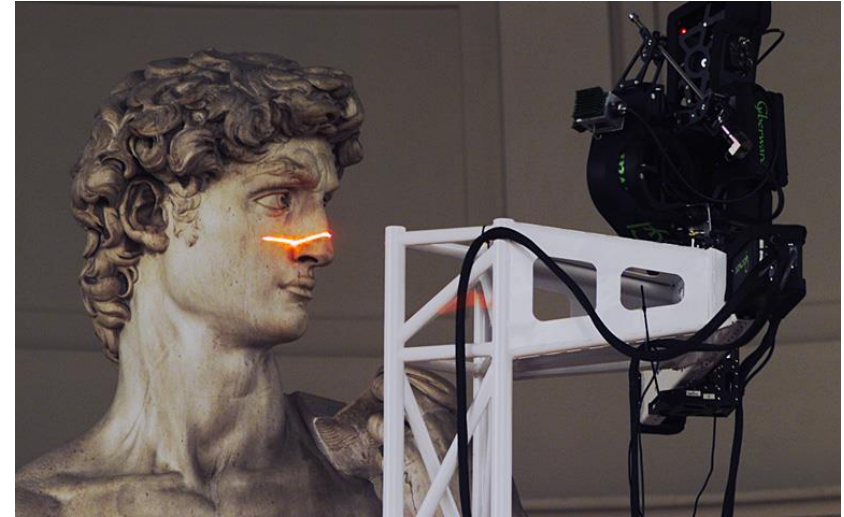
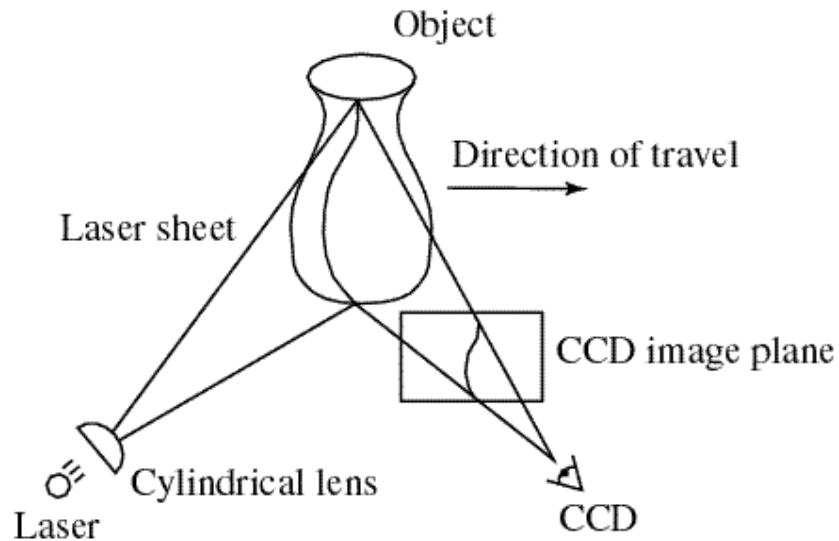

Digital Michelangelo Project
<http://graphics.stanford.edu/projects/mich/>

- **Optical triangulation**
 - Project a single stripe of laser light
 - Scan it across the surface of the object
 - This is a very precise version of structured light scanning

Laser Scanned Models



The Digital Michelangelo Project, Levoy et al.

Laser Scanned Models



The Digital Michelangelo Project, Levoy et al.

Laser Scanned Models

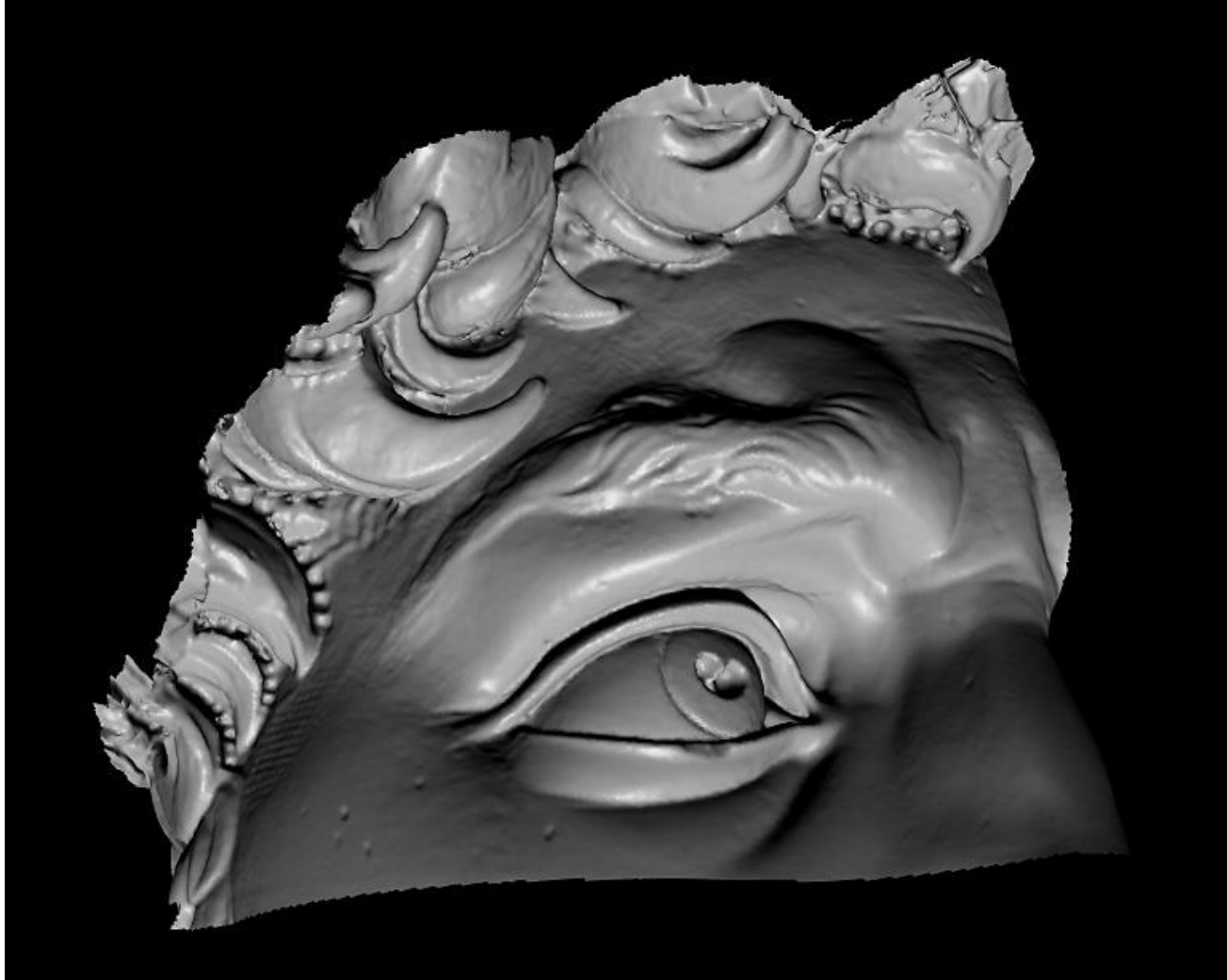

The Digital Michelangelo Project, Levoy et al.

Laser Scanned Models

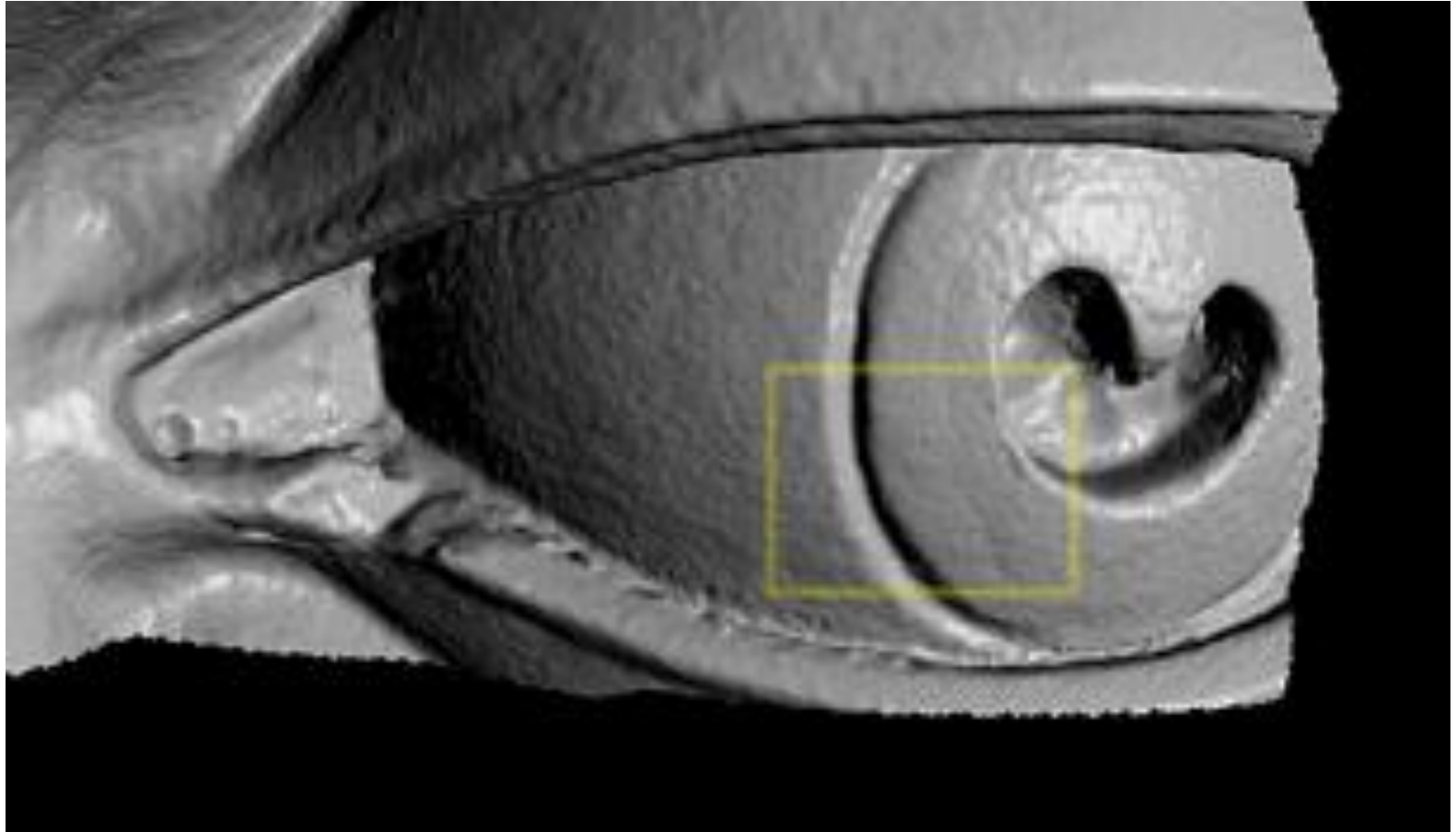

The Digital Michelangelo Project, Levoy et al.

Laser Scanned Models

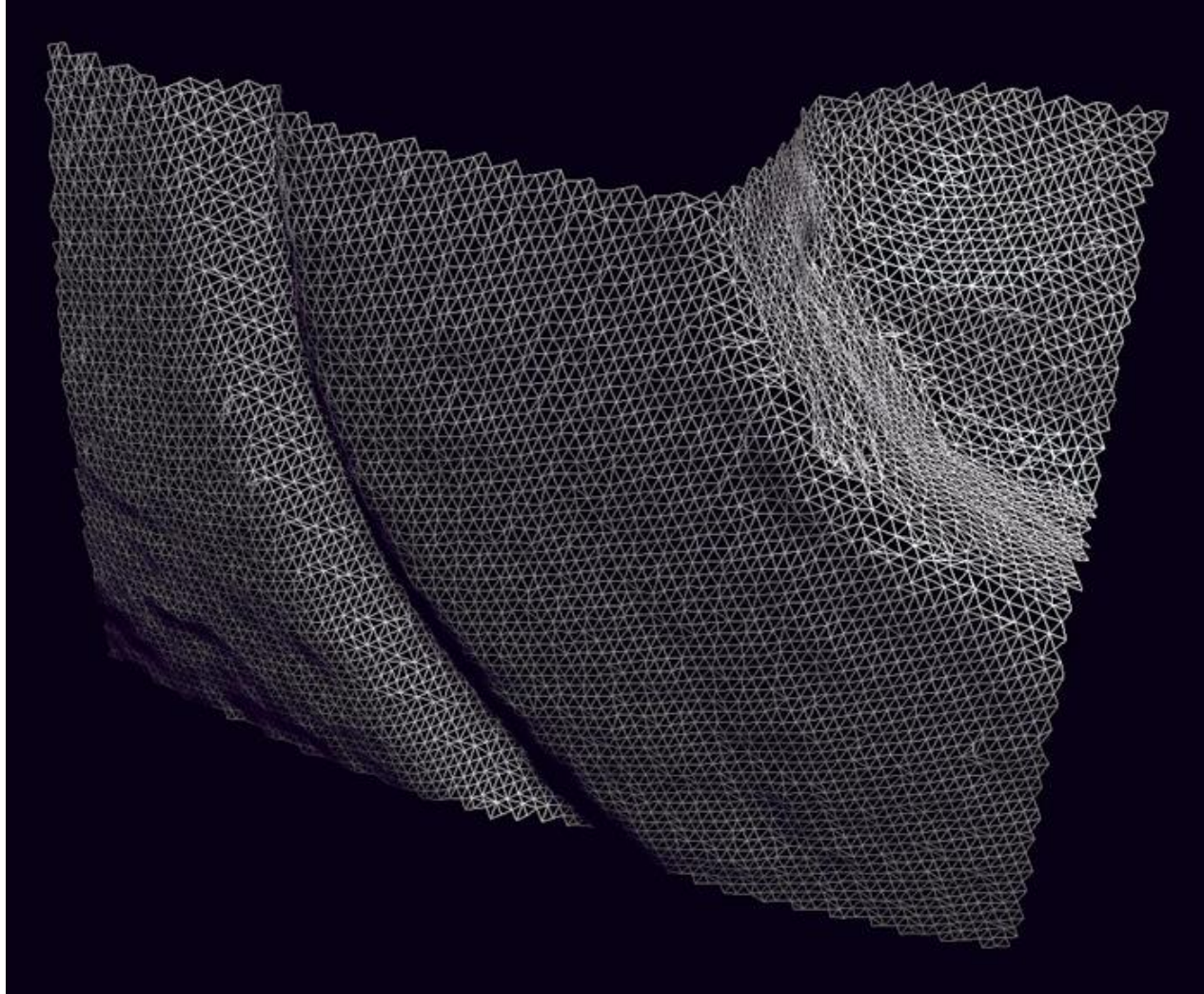

The Digital Michelangelo Project, Levoy et al.

Multi-Stripe Triangulation

- To go faster, project multiple stripes
- But which stripe is which?
- Answer #1: assume surface continuity

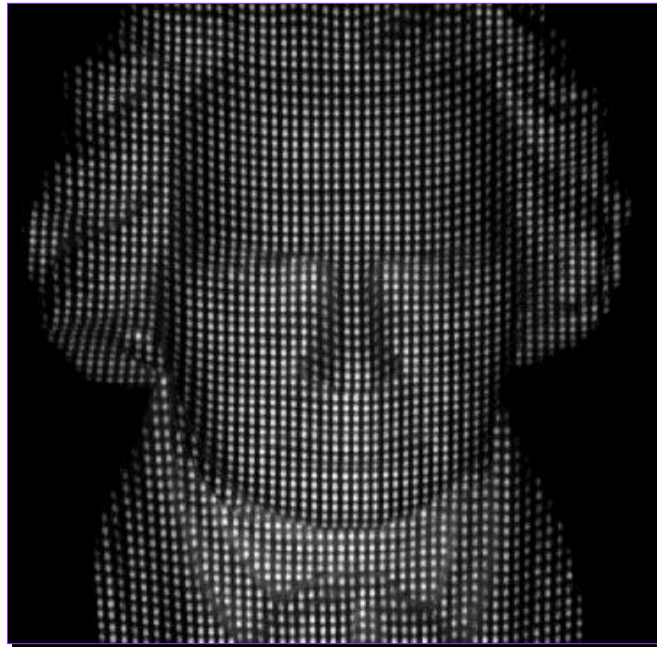

e.g. Eyetronics' ShapeCam



Multi-Stripe Triangulation

- To go faster, project multiple stripes
- But which stripe is which?
- Answer #2: colored stripes (or dots)

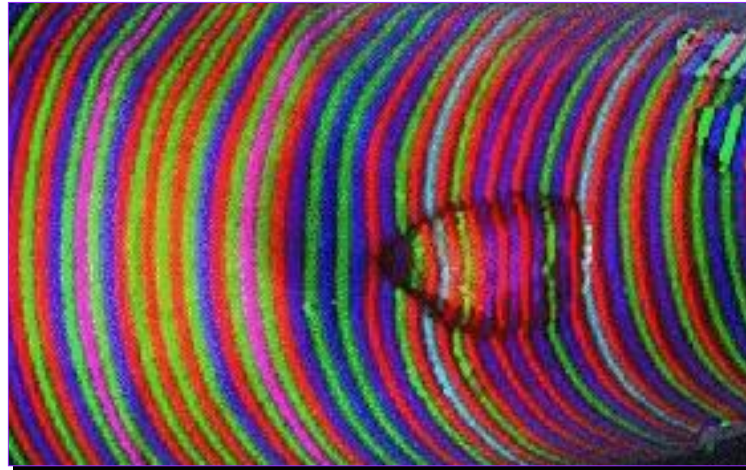

L. Zhang, B. Curless, and S. M. Seitz. [Rapid Shape Acquisition Using Color Structured Light and Multi-pass Dynamic Programming](#). *3DPVT 2002*

Multi-Stripe Triangulation

- To go faster, project multiple stripes
- But which stripe is which?
- Answer #3: time-coded stripes



O. Hall-Holt, S. Rusienkiewicz, [Stripe Boundary Codes for Real-Time Structured-Light Scanning of Moving Objects](#), ICCV 2001.

Time-Coded Light Patterns

- Assign each stripe a unique illumination code over time [Posdamer 82]

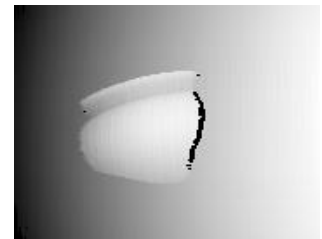
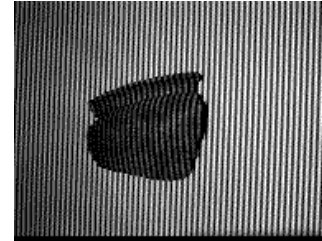
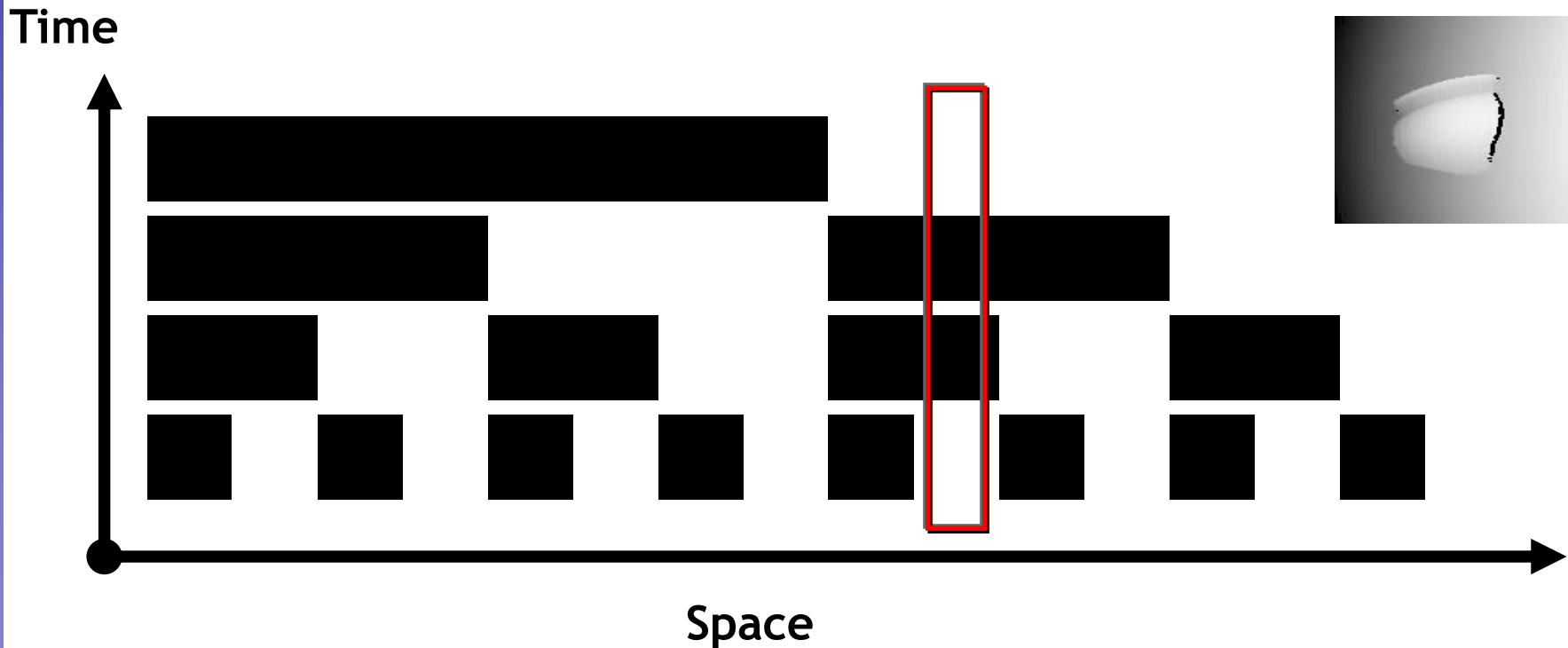

Better codes...

- Gray code
Neighbors only differ one bit

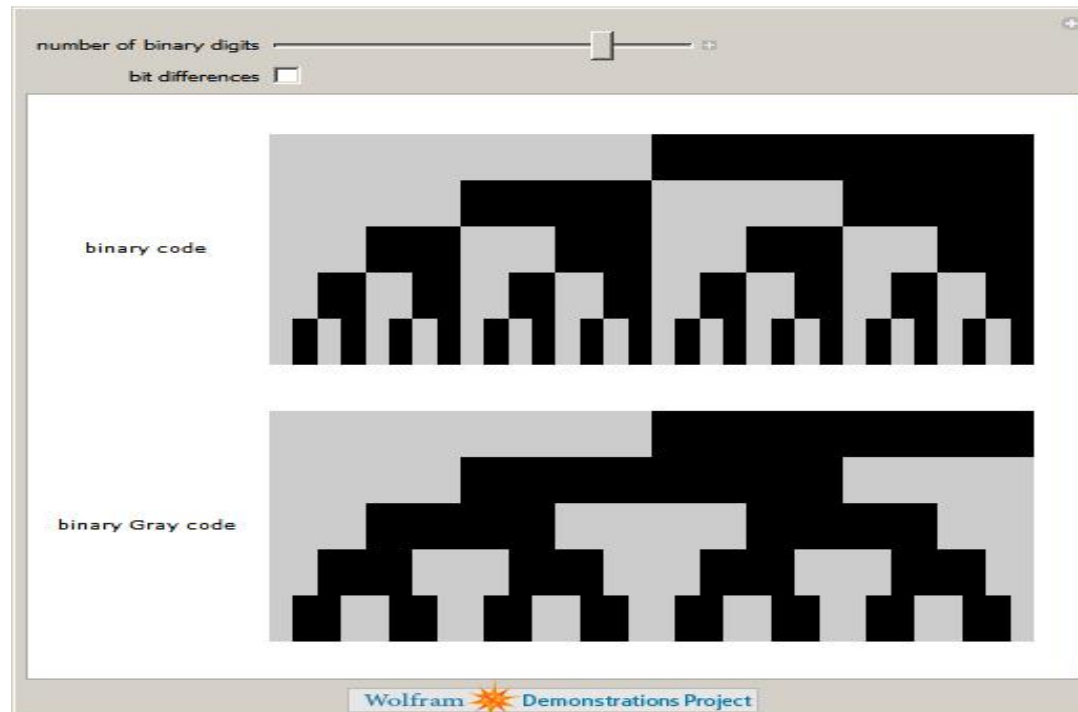

Phase-Shift Structured Light Scanning

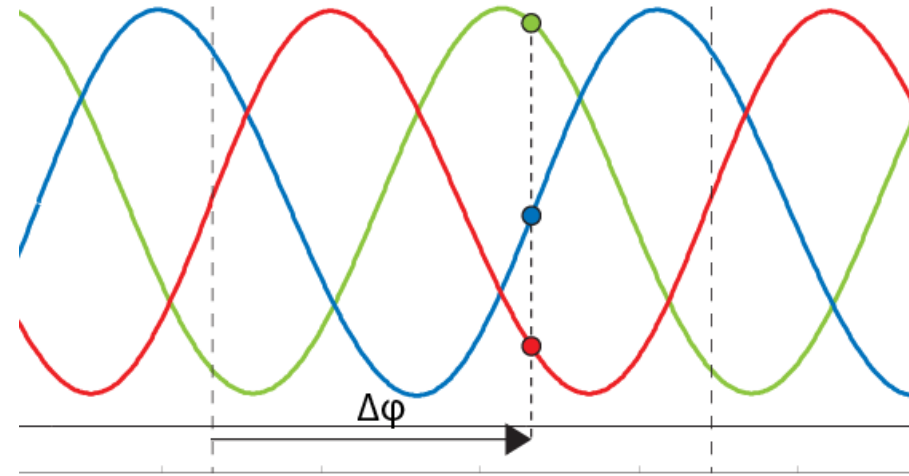

$$\Delta\varphi = \arctan \left(\frac{\sqrt{3} (I_r - I_b)}{(2 I_g - I_r - I_b)} \right)$$



Cameras



Projector

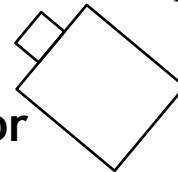

- **Faster procedure by projecting continuous patterns**
 - Project 3 sinusoid grating patterns shifted by 120° in phase.
 - For each pixel, compute **relative phase** from 3 intensities.
 - Recover **absolute phase** by adding a 2nd camera.

A High-Speed 3D Scanner

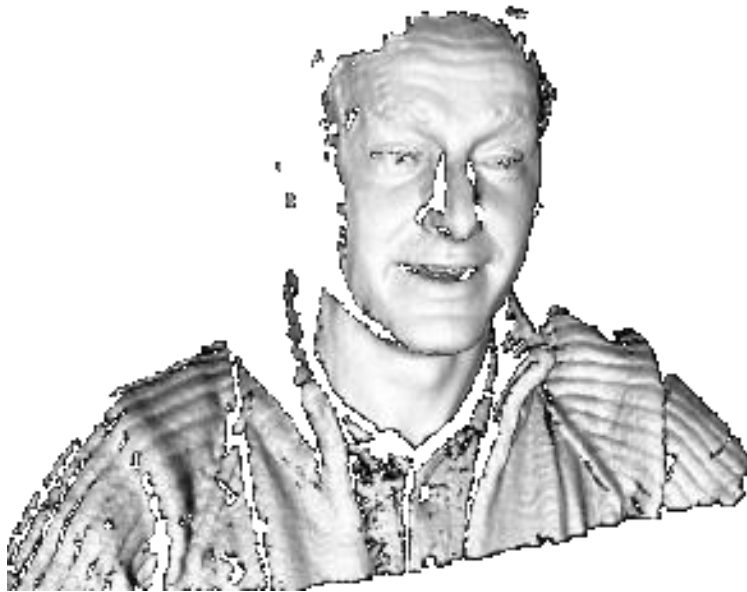

Dense 3D reconstructions
at 30 fps (on the GPU)

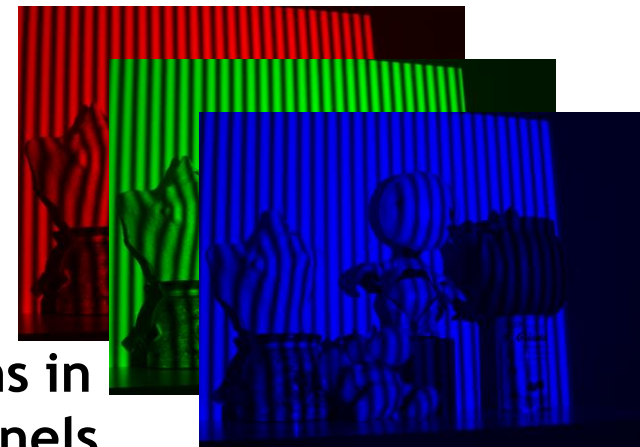
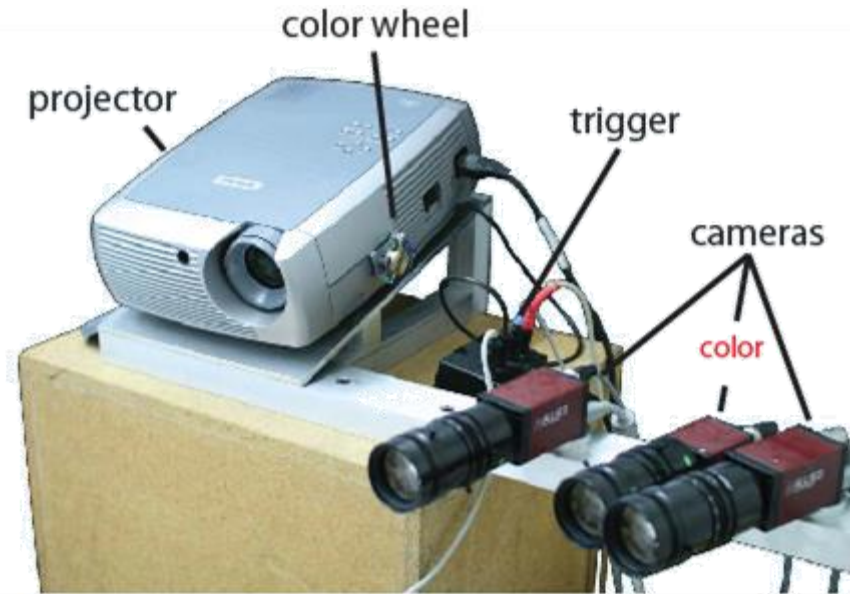

Project patterns in
all 3 color channels
(color wheel removed)

Problems with Dynamically Moving Objects

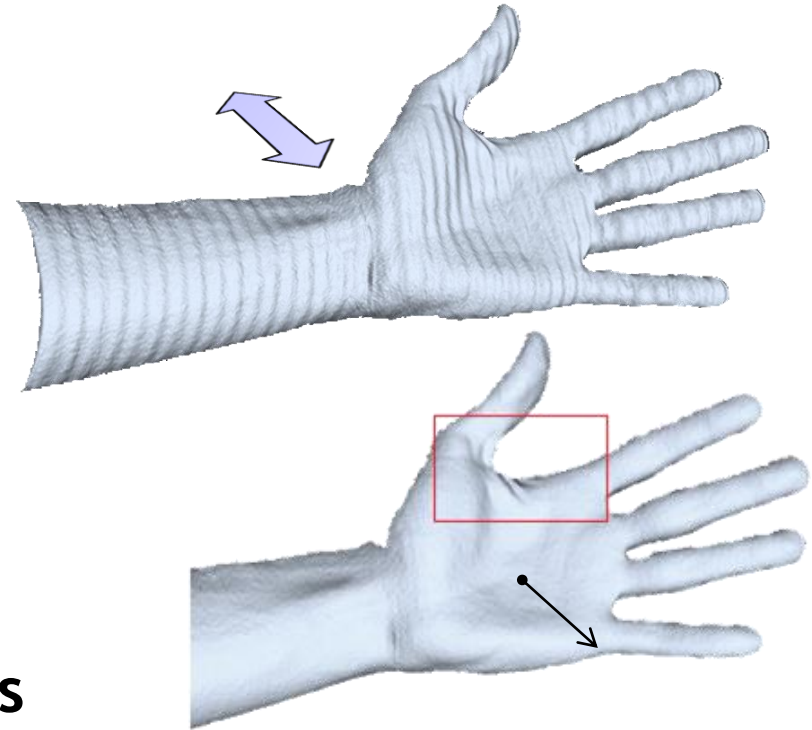
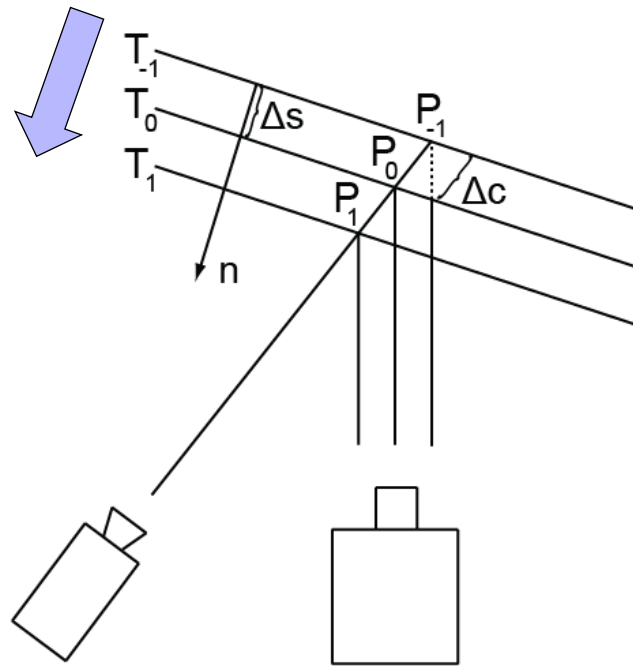

- **Moving objects lead to artifacts**
 - Measurements correspond to different 3D points!
 - **Derived a geometric model for the error**
 - Designed a motion compensation method
- ⇒ **Result: Cleaned-up geometry + motion estimate!**

Effect of Motion Compensation



Hand Gestures

Application: Online Model Reconstruction

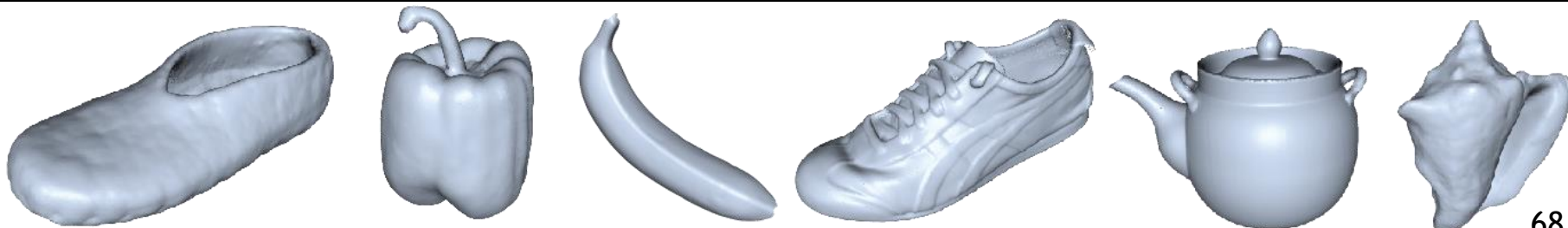
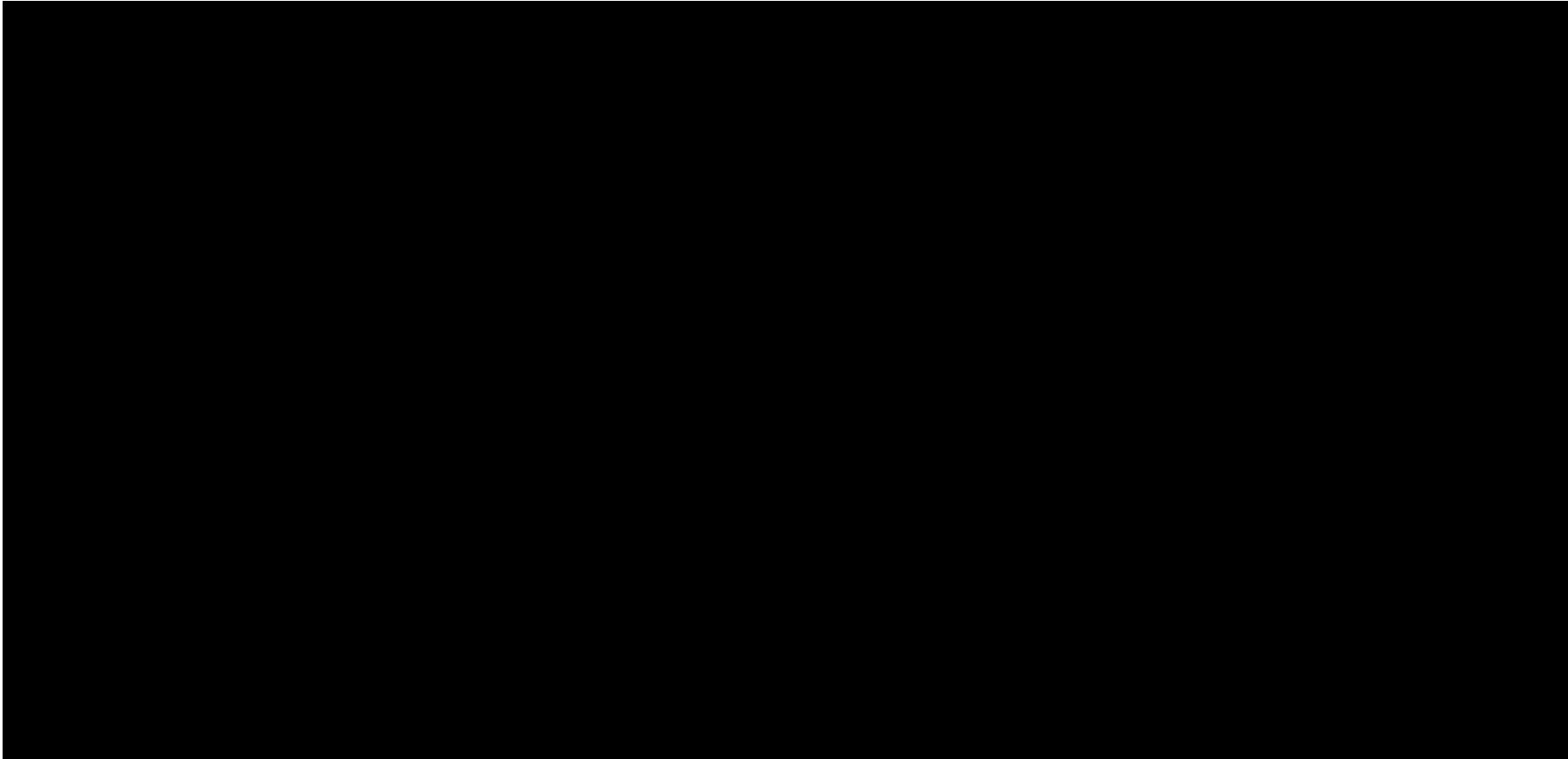

[Weise, Leibe, Van Gool, CVPR'08; 3DIM'09]

Poor Man's Scanner

The idea

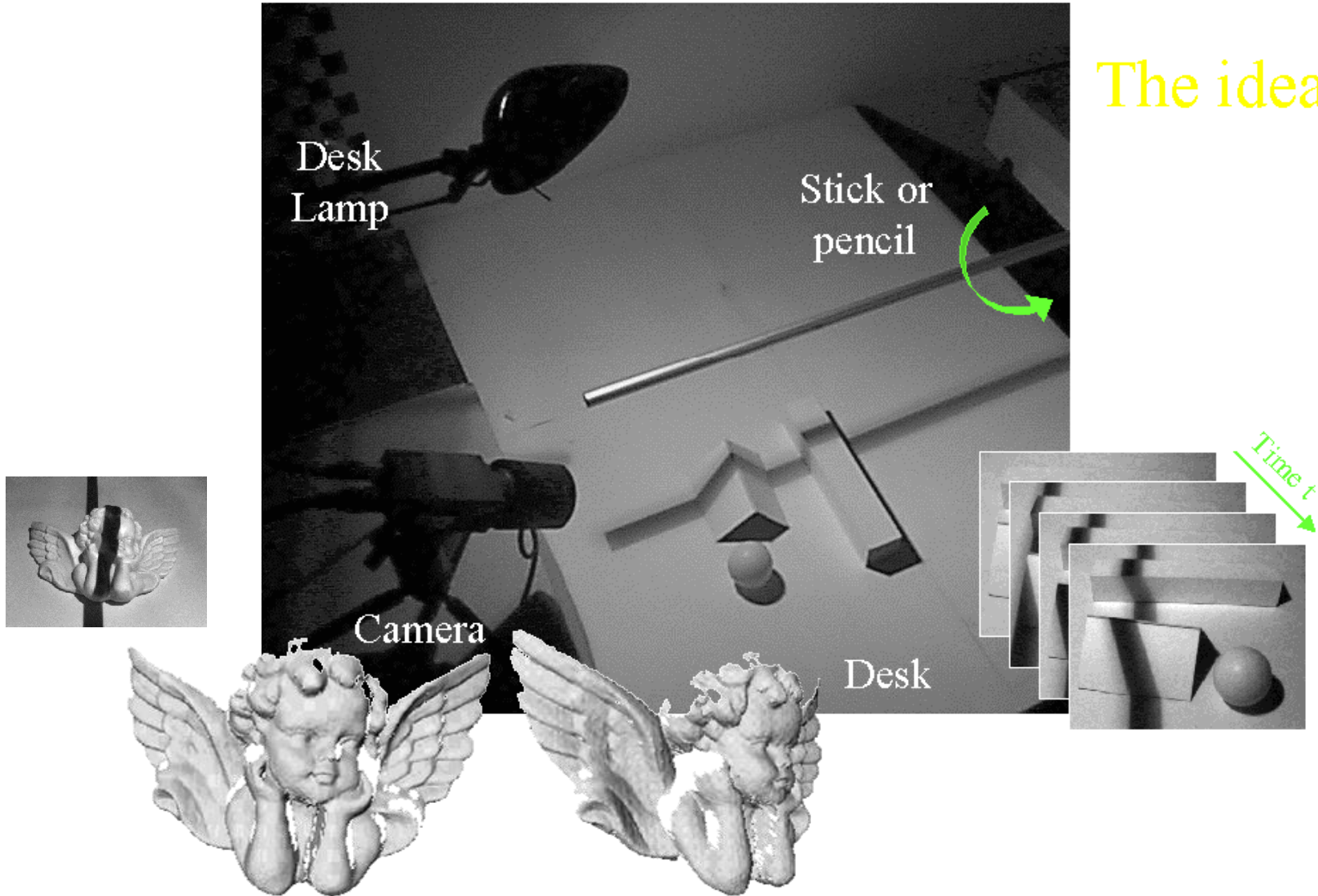

Slightly More Elaborate (But Still Cheap)



Software freely available from Robotics Institute TU Braunschweig
<http://www.david-laserscanner.com/>

References and Further Reading

- Background information on camera models and calibration algorithms can be found in Chapters 6 and 7 of

R. Hartley, A. Zisserman
Multiple View Geometry in Computer Vision
2nd Ed., Cambridge Univ. Press, 2004

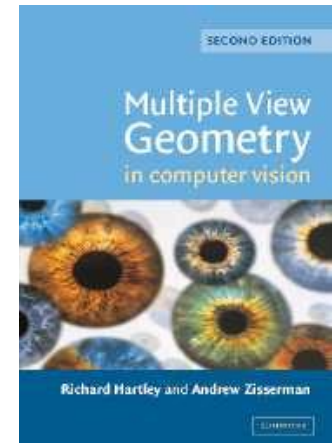

- Also recommended: Chapter 9 of the same book on Epipolar geometry and the Fundamental Matrix and Chapter 11.1-11.6 on automatic computation of F .